



Operator's Manual

# HQ682

Tough Cut Mower





View all manuals



500 Venture Drive  
Orrville Oh 44667  
www.ventrac.com

Visit [ventrac.com/manuals](http://ventrac.com/manuals) for the latest version of this operator's manual.

A downloadable parts manual is also available.

### To the Owner Contact Information and Product Identification

If you need to contact an authorized Ventrac dealer for information on servicing your product, always provide the product model and serial numbers.

Please fill in the following information for future reference. See the picture(s) below to find the location of the identification numbers. Record them in the spaces provided.

Date of Purchase: \_\_\_\_\_

Dealer: \_\_\_\_\_

Dealer Address: \_\_\_\_\_  
\_\_\_\_\_

Dealer Phone Number: \_\_\_\_\_

Dealer Fax Number: \_\_\_\_\_

Model # (A): \_\_\_\_\_

Serial # (B): \_\_\_\_\_

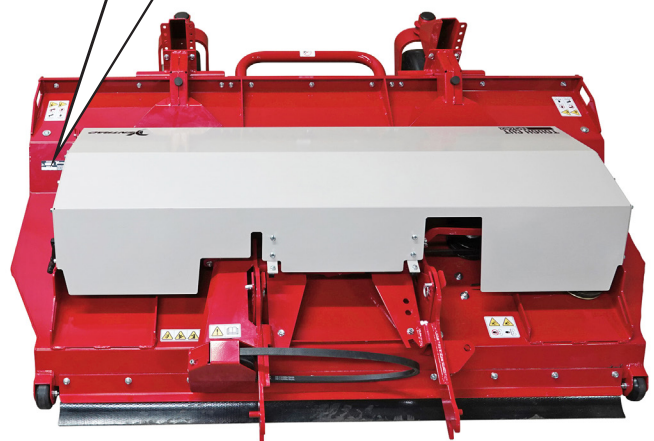
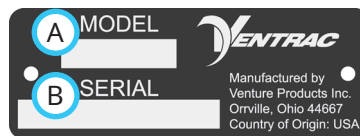

Venture Products Inc. reserves the right to make changes in design or specifications without obligation to make like changes on previously manufactured products.

# TABLE OF CONTENTS

---

<b>INTRODUCTION</b>	<b>PAGE 5</b>
Product Description . . . . .	5
Why Do I Need an Operator’s Manual? . . . . .	5
Using Your Manual . . . . .	6
Manual Glossary . . . . .	6
<b>SAFETY</b>	<b>PAGE 7</b>
General Safety Procedures . . . . .	7
Training Required . . . . .	7
Requirements for Personal Protective Equipment (PPE) . . . . .	7
Operation Safety. . . . .	7
Keep Riders Off . . . . .	9
Operating On Slopes . . . . .	9
Truck Or Trailer Transport . . . . .	10
Maintenance . . . . .	10
Fuel Safety . . . . .	11
Hydraulic Safety . . . . .	12
Cutting Unit Safety . . . . .	13
Optional Hydraulic Flip Up Kit Safety . . . . .	13
Safety Decals . . . . .	14
<b>OPERATIONAL CONTROLS</b>	<b>PAGE 16</b>
Main Belt Tension Handle . . . . .	16
Right Belt Tension Spring . . . . .	16
Hitch Arm Pins . . . . .	16
Primary SDLA Control Lever . . . . .	16
Secondary SDLA Control Lever . . . . .	16
Weight Transfer . . . . .	16
<b>GENERAL OPERATION</b>	<b>PAGE 17</b>
Daily Inspection . . . . .	17
Attaching . . . . .	17
Detaching. . . . .	17
Operating Procedure . . . . .	17
Transport of the Attachment. . . . .	18
Cutting Height Adjustment (Fixed Wheels) . . . . .	18
Cutting Height Adjustment (Swivel Wheels) . . . . .	19
Swivel Wheel Outer Position . . . . .	19

# TABLE OF CONTENTS

---

<b>SERVICE</b>	<b>PAGE 20</b>
Cleaning and General Maintenance . . . . .	20
Deck Cover Removal and Installation . . . . .	20
Deck Flip Up Procedure (Service Position) . . . . .	20
Mower Blade Inspection/Replacement . . . . .	21
Mower Blade Sharpening . . . . .	21
Belt Inspection . . . . .	22
Attachment Drive Belt Replacement . . . . .	22
Main Deck Belt Replacement . . . . .	22
Right Deck Belt Replacement . . . . .	23
Main Deck Belt Tension Adjustment . . . . .	23
Lubrication Locations . . . . .	24
Storage . . . . .	24
Maintenance Schedule . . . . .	25
Maintenance Checklist . . . . .	25
<b>SPECIFICATIONS</b>	<b>PAGE 26</b>
Dimensions . . . . .	26
Features . . . . .	26

# INTRODUCTION



Ventrac Products Inc. is pleased to provide you with your new Ventrac tough cut mower! We hope that Ventrac equipment will provide you with a ONE Tractor Solution.

Please visit our website, or contact your authorized Ventrac dealer for a complete list of items available for your new tough cut mower.

Accessories	Item Description	Part Number
	Hydraulic Deck Flip Up Kit	70.8226

## Product Description

The HQ682 tough cut mower is designed for mowing high grass, thick weeds, and brush. A large baffled front opening allows brush to enter for cutting and hinders debris from escaping.

Three heavy duty, counter-rotating blades cut and drop materials evenly without windrowing. Capable of cutting material up to 2-1/2 cm (1 inch), the tough cut mower makes short work out of heavy brush.

When using the swivel wheels, the HQ682 tough cut mower features a cutting height range from 89 - 178 mm (3-1/2 - 7 inches) in 12.7 mm (1/2 inch) increments.

When using the fixed wheels, the HQ682 tough cut mower features cutting heights of 76, 92, or 108 mm (3, 3-5/8, or 4-1/4 inches).

The deck can be tilted up to access the underside of the deck for cleaning and maintenance. An optional hydraulic deck flip up kit uses the power unit hydraulic system to flip the deck up to the service position.

## Why Do I Need an Operator's Manual?

This manual has been created to help you gain the important knowledge of what is needed to safely operate, maintain, and service your machine. It is divided into sections for convenient reference of the appropriate section.

You must read and understand the operator's manual for each piece of Ventrac equipment you own. Reading the operator's manual will help you become familiar with each specific piece of equipment. Understanding the operator's manual will help you, as well as others, avoid personal injury and/or damage to the equipment. Keep this manual with the machine at all times. The manual should remain with the machine even if it is sold. If this manual becomes damaged or unreadable, it should be replaced immediately. Contact your local Ventrac dealer for a replacement.

When using a Ventrac attachment, be sure to read and follow the safety and operating instructions of both the power unit and the attachment being used to ensure the safest operation possible.

The information in this manual provides the operator with the safest procedures to operate the machine while getting the maximum use out of the unit. Failure to follow the safety precautions listed in this manual may result in personal injury and/or damage to the equipment.

# INTRODUCTION

## Using Your Manual

Throughout this manual, you will encounter special messages and symbols that identify potential safety concerns to help you as well as others avoid personal injury or damage to the equipment.

### SYMBOL DEFINITIONS

#### **ATTENTION**

 This symbol identifies potential health and safety hazards. It marks safety precautions. Your safety and the safety of others is involved.

There are three signal words that describe the level of safety concern: Danger, Warning, and Caution. Safety should always be the first priority when working on or operating equipment. Accidents are more likely to occur when proper operating procedures are not followed or inexperienced operators are involved.

Note: Right-Hand and Left-Hand orientations may be referred to at different places throughout this manual. Right-Hand and Left-Hand is determined as if facing forward from the operator station.

### SIGNAL WORD DEFINITIONS

#### **DANGER**

Indicates an imminently hazardous situation which, if not avoided, will result in death or serious injury. This signal word is limited to the most extreme cases.

#### **WARNING**

Indicates a potentially hazardous situation which, if not avoided, could result in death or serious injury.

#### **CAUTION**

Indicates a potentially hazardous situation which, if not avoided, may result in minor or moderate injury and/or property damage. It may also be used to alert against unsafe practices.

## Manual Glossary

- Power Unit** A Ventrac tractor or other Ventrac engine powered device that may be operated by itself or with an attachment or accessory.
- Attachment** A piece of Ventrac equipment that requires a Power Unit for operation.
- Accessory** A device that attaches to a Power Unit or Attachment to extend its capabilities.
- Machine** Describes any "Attachment" or "Accessory" that is used in conjunction with a power unit.

# SAFETY

---



## General Safety Procedures for Ventrac Power Units, Attachments, & Accessories



### Training Required

- The owner of this machine is solely responsible for properly training the operators.
- The owner/operator is solely responsible for the operation of this machine and for the prevention of accidents or injuries occurring to him/herself, other people, or property.
- Do not allow operation or service by children or untrained personnel. Local regulations may restrict the age of the operator.
- Before operating this machine, read the operator's manual and understand its contents.
- If the operator of the machine cannot understand this manual, then it is the responsibility of this machine's owner to fully explain the material within this manual to the operator.
- Learn and understand the use of all the controls.
- Know how to stop the power unit and the attachments quickly in the event of an emergency.

### Requirements for Personal Protective Equipment (PPE)

- The owner is responsible for ensuring that all the operators use the proper PPE while operating the machine. Whenever you use the machine, use the following PPE:
- Certified eye protection and hearing protection.
- Closed toe, slip resistant footwear.
- Long pants or trousers.
- A dust mask for dusty conditions.
- Additional PPE may be required. Refer to the product safety procedures for any additional requirements.

### Operation Safety

- Secure long hair and loose clothing. Do not wear jewelry.
- Inspect the machine before operation. Repair or replace any damaged, worn, or missing parts. Be sure the guards and shields are in proper working condition and are secured in place. Make any necessary adjustments before operating the machine.
- Some pictures in this manual may show shields or covers opened or removed in order to clearly illustrate the instructions. Under no circumstance should the machine be operated without these devices in place.
- Alterations or modifications to this machine can reduce safety and could cause damage to the machine. Do not alter the safety devices or operate with the shields or covers removed.
- Before each use, verify that all the controls function properly and inspect all the safety devices. Do not operate if the controls or safety devices are not in proper working condition.
- Check the parking brake function before operating. Repair or adjust the parking brake if necessary.
- Observe and follow all of the safety decals.
- All the controls are to be operated from the operator's station only.
- Always wear a seat belt if the machine has a roll cage/bar installed and in the upright position.

# SAFETY

---



## General Safety Procedures for Ventrac Power Units, Attachments, & Accessories



- Ensure the attachment or accessory is locked or fastened securely to the power unit before operating.
- Ensure that all bystanders are clear of the power unit and the attachment before operating. Stop the machine if someone enters your work area.
- Always be alert to what is happening around you, but do not lose focus on the task you are performing. Always look in the direction the machine is moving.
- Look behind and down before backing up to be sure of a clear path.
- If you hit an object, stop and inspect the machine. Make any necessary repairs before operating the machine again.
- Stop operation immediately at any sign of equipment failure. An unusual noise can be a warning of equipment failure or a sign that maintenance is required. Make any necessary repairs before operating the machine again.
- If equipped with a high/low range feature, never shift between high and low range while on a slope. Always move the machine to level ground and engage the parking brake before shifting range.
- Do not leave the machine unattended while it is running.
- Always park the machine on level ground.
- Always shut off the engine when connecting the attachment drive belt to the power unit.
- Never leave the operator's station without lowering the attachment to the ground, engaging the parking brake, shutting off the engine, and removing the ignition key. Make sure all moving parts have come to a complete stop before dismounting.
- Never leave the machine unattended without lowering the attachment to the ground, engaging the parking brake, shutting off the engine, and removing the ignition key.
- Only operate in well-lit conditions.
- Do not operate when there is a risk of lightning.
- Never direct the discharge of any attachment in the direction of people, buildings, animals, vehicles, or other objects of value.
- Never discharge material against a wall or obstruction. The material may ricochet back toward the operator.
- Use extra caution when approaching blind corners, shrubs, trees, or other objects that may obscure your vision.
- Do not run the engine in a building without adequate ventilation.
- Do not touch the engine or the muffler while the engine is running or immediately after stopping the engine. These areas may be hot enough to cause a burn.
- Do not change the engine governor settings or over-speed the engine. Operating the engine at excessive speeds may increase the hazard of personal injury.
- To reduce the hazard of fire, keep the battery compartment, engine, and muffler areas free of grass, leaves, excessive grease, and other flammable materials.
- Clear the working area of objects that might be hit or thrown from the machine.



# SAFETY

---



## General Safety Procedures for Ventrac Power Units, Attachments, & Accessories



- Keep people and pets out of the working area.
- Know the work area well before operation. Do not operate where traction or stability is questionable.
- Reduce speed when you are operating over rough ground.
- Equipment can cause serious injury and/or death when improperly used. Before operating, know and understand the operation and safety of the power unit and the attachment being used.
- Do not operate the machine if you are not in good physical and mental health, if you will be distracted by personal devices, or if you are under the influence of any substance which might impair your decisions, dexterity, or judgment.
- Children are attracted to machine activity. Be aware of children and do not allow them in the work area. Turn off the machine if a child enters the work area.
- Power units, attachments, and accessories are not designed or intended for travel on public roadways. Never operate or travel on public roads or highways.
- Operate with safety lights when operating near roadways.
- Slow down and be careful of traffic when operating near or crossing roadways. Stop before crossing roads or sidewalks. Use care when approaching areas or objects that may obscure vision.

### Keep Riders Off

- Only allow the operator on the power unit. Keep riders off.
- Never allow riders on any attachment or accessory.

### Operating On Slopes

- Slopes can cause loss-of-control and tip-over accidents, which can result in severe injury or death. Be familiar with the emergency parking brake, along with the power unit controls and their functions.
- If the power unit is equipped with a fold down roll bar, it must be locked in the upright position when operating on any slope.
- Use low range (if equipped) when operating on slopes greater than 15 degrees.
- Do not stop or start suddenly when operating on slopes.
- Never shift between high and low range while on a slope. Always move the power unit to level ground and engage the parking brake before shifting range or placing the power unit in neutral.
- Variables such as wet surfaces and loose ground will reduce the degree of safety. Do not drive where the machine could lose traction or tip over.
- Keep alert for hidden hazards in the terrain.
- Stay away from drop-offs, ditches, and embankments.
- Sharp turns should be avoided when operating on slopes.
- Pulling loads on hills decreases safety. It is the responsibility of the owner/operator to determine loads that can safely be controlled on slopes.

# SAFETY

---



## General Safety Procedures for Ventrac Power Units, Attachments, & Accessories



- Transport the machine with the attachment lowered or close to the ground to improve stability.
- While operating on slopes, drive in an up and down direction whenever possible. If turning is necessary while driving across slopes, reduce your speed and turn slowly in the downhill direction.
- Ensure a sufficient supply of fuel for continuous operation. A minimum of one-half tank of fuel is recommended.

### Truck Or Trailer Transport

- Use care when loading or unloading the machine into a truck or trailer.
- Use full width ramps for loading the machine into a truck or trailer.
- The parking brake is not sufficient to lock the machine during transport. Always secure the power unit and/or attachment to the transporting vehicle securely using straps, chains, cables, or ropes. Both the front and rear straps should be directed down and outward from the machine.
- Shut off the fuel supply to the power unit during transport on a truck or trailer.
- If equipped, turn the battery disconnect switch to the Off position to shut off electrical power.

### Maintenance

- Keep the safety decals legible. Remove all grease, dirt, and debris from the safety decals and instructional labels.
- If any decals are faded, illegible, or missing, contact your dealer promptly for replacements.
- When new components are installed, be sure that the current safety decals are affixed to the replacement components.
- If any component requires replacement, use only original Ventrac replacement parts.
- Always turn the battery disconnect to the Off position or disconnect the battery before performing any repairs. Disconnect the negative terminal first and the positive terminal last. Reconnect the positive terminal first and the negative terminal last.
- Keep all bolts, nuts, screws, and other fasteners properly tightened.
- Always lower the attachment to the ground, engage the parking brake, shut off the engine, and remove the ignition key. Make sure all moving parts have come to a complete stop before cleaning, inspecting, adjusting, or repairing.
- If the power unit, attachment, or accessory requires repairs or adjustments not instructed in the operator's manual, the power unit, attachment, or accessory must be taken to an authorized Ventrac dealer for service.
- Never perform maintenance on the power unit and/or attachment if someone is in the operator's station.
- Always use protective glasses when handling the battery.
- Check the fuel lines for tightness and wear on a regular basis. Tighten or repair them as needed.
- To reduce the hazard of fire, keep the battery compartment, engine, and muffler areas free of grass, leaves, and excess grease.
- Do not touch the engine, the muffler, or other exhaust components while the engine is running or immediately after stopping the engine. These areas may be hot enough to cause a burn.

# SAFETY

---



## General Safety Procedures for Ventrac Power Units, Attachments, & Accessories



- Allow the engine to cool before storing and do not store near an open flame.
- Do not change the engine governor settings or over-speed the engine. Operating engine at excessive speeds may increase the hazard of personal injury.
- Springs may contain stored energy. Use caution when disengaging or removing springs and/or spring loaded components.
- An obstruction or blockage in a drive system or moving/rotating parts may cause a buildup of stored energy. When the obstruction or blockage is removed, the drive system or moving/rotating parts may move suddenly. Do not attempt to remove an obstruction or blockage with your hands. Keep your hands, feet, and clothing away from all power-driven parts.

### Fuel Safety

- To avoid personal injury or property damage, use extreme care in handling gasoline. Gasoline is extremely flammable and the vapors are explosive.
- Do not refuel the machine while smoking or at a location near flames or sparks.
- Always refuel the machine outdoors.
- Do not store the machine or fuel container indoors where the fumes or fuel can reach an open flame, spark, or pilot light.
- Only store fuel in an approved container. Keep out of the reach of children.
- Never fill containers inside a vehicle or on a truck or trailer bed with a plastic liner. Always place the containers on the ground away from your vehicle before filling.
- Remove the machine from the truck or trailer and refuel it on the ground. If this is not possible, refuel the machine using a portable container, rather than from a fuel dispenser nozzle.
- Never remove the fuel cap or add fuel with the engine running. Allow the engine to cool before refueling.
- Never remove the fuel cap while on a slope. Only remove the fuel cap when parked on a level surface.
- Replace the fuel tank cap and the container cap securely.
- Do not overfill the fuel tank. Only fill to the bottom of the fuel neck, do not fill the fuel neck full. Overfilling of the fuel tank could result in engine flooding, fuel leakage from the tank, and/or damage to the emissions control system.
- If fuel is spilled, do not attempt to start the engine. Move the power unit away from the fuel spill and avoid creating any source of ignition until the fuel vapors have dissipated.
- If the fuel tank must be drained, it should be drained outdoors into an approved container.
- Check the fuel lines for tightness and wear on a regular basis. Tighten or repair them as needed.
- The fuel system is equipped with a shut-off valve. Shut off the fuel when transporting the machine to and from the job, when parking the machine indoors, or when servicing the fuel system.

# SAFETY

---



## General Safety Procedures for Ventrac Power Units, Attachments, & Accessories



### Hydraulic Safety

- Make sure the hydraulic connections are tight and all hydraulic hoses and tubes are in good condition. Repair any leaks and replace any damaged or deteriorated hoses or tubes before starting the machine.
- Hydraulic leaks can occur under high pressure. Hydraulic leaks require special care and attention.
- Use a piece of cardboard and a magnifying glass to locate suspected hydraulic leaks.
- Keep your body and hands away from pinhole leaks or nozzles that eject high pressure hydraulic fluid. Hydraulic fluid escaping under high pressure can penetrate the skin causing serious injury, leading to severe complications and/or secondary infections if left untreated. If hydraulic fluid is injected into the skin, seek immediate medical attention no matter how minor the injury appears.
- The hydraulic system may contain stored energy. Before performing maintenance or repairs on the hydraulic system, remove any attachments, engage the parking brake, disengage the weight transfer system (if equipped), shut off the engine, and remove the ignition key. To relieve pressure on the auxiliary hydraulic system, shut off the power unit engine and move the hydraulic control lever left and right before disconnecting the auxiliary hydraulic quick couplers.

# SAFETY

---



## HQ682 Safety Procedures



Tall grass and thick brush can hide large obstacles such as rocks, tree stumps, etc.

- Inspect the work area for hidden obstacles and remove or mark any obstacles before beginning operation.
- Inspect the work area and remove any objects that could potentially be thrown from the machine.

### **Cutting Unit Safety**

- Rotating Blade Hazard: Contact with the rotating mower blades or other moving parts may cause personal injury. Keep your hands and feet away.
- Rotation of one blade may cause another blade to rotate.
- Thrown Object Hazard: Do not direct the mower discharge toward people, animals, or buildings. Never operate with the deflector(s) removed.
- Always shut off the PTO to stop the mower blades whenever you are not mowing, especially when crossing loose terrain such as gravel.
- Never raise the mower deck with the blades running.

### **Optional Hydraulic Flip Up Kit Safety**

- Attachment hydraulic system may contain stored energy. Before performing maintenance or repairs on the hydraulic system, the attachment's auxiliary hydraulic hoses must be disconnected from the power unit. Lower the attachment to the ground, shut off power unit engine, move the secondary SDLA lever left and right to relieve auxiliary hydraulic pressure, and disconnect the auxiliary hydraulic quick couplers.
- Do not disconnect the auxiliary hydraulic hoses for the optional flip up kit while the deck is in the flip up (service) position.

# SAFETY

## Safety Decals

The following safety decals must be maintained on your attachment.

Keep all safety decals legible. Remove all grease, dirt, and debris from safety decals and instructional labels. If any decals are faded, illegible, or missing, contact your dealer promptly for replacements.

When new components are installed, be sure that current safety decals are affixed to the replacement components.

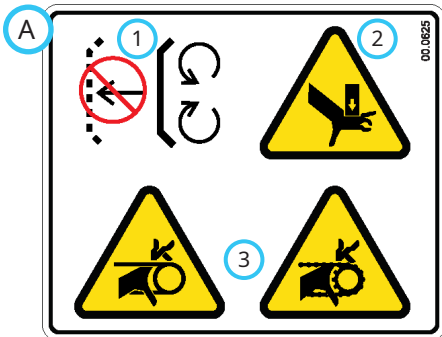
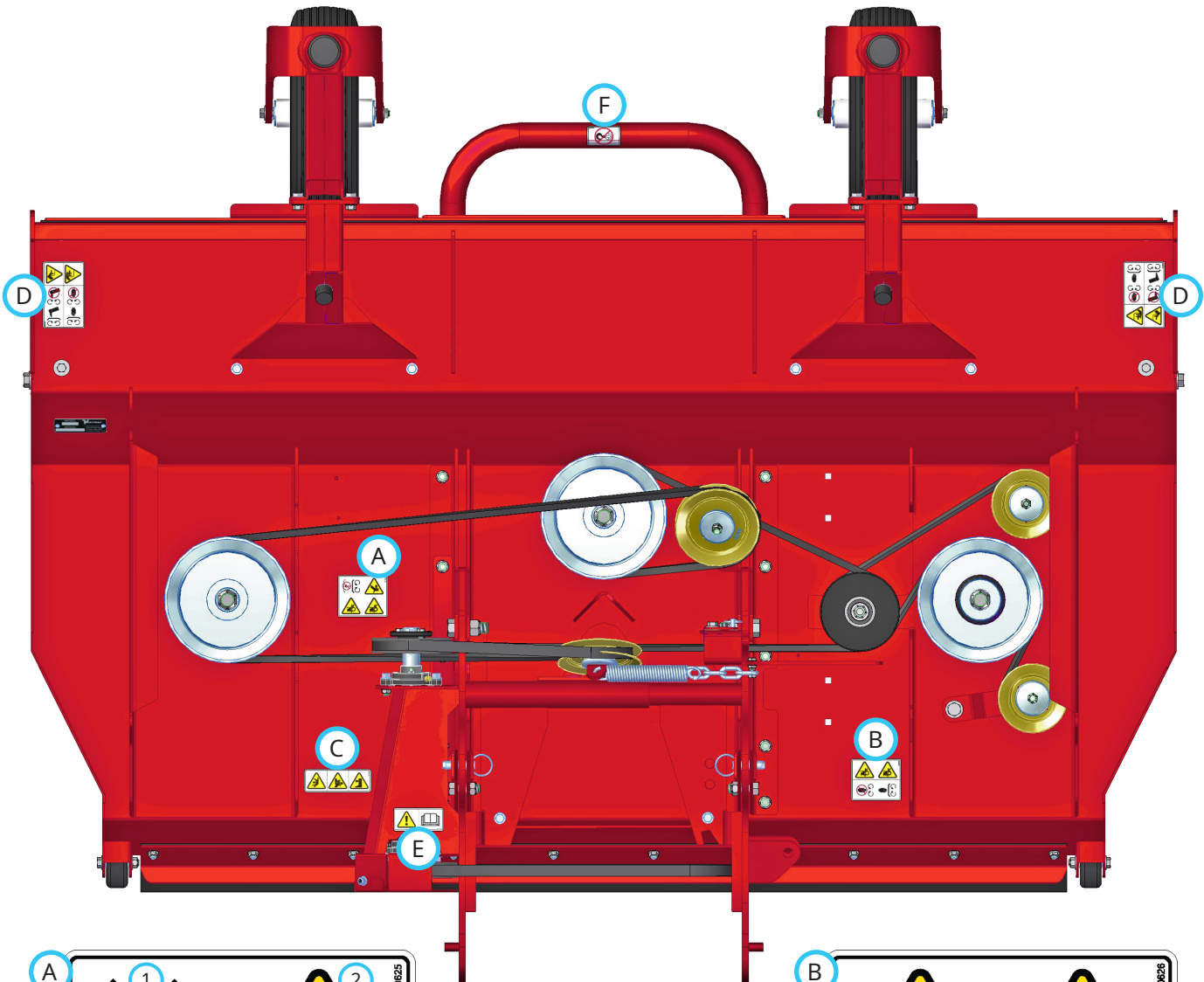

1. Shield missing - do not operate.
2. Pinching/crushing hazard.
3. Fingers or hand entanglement hazard.

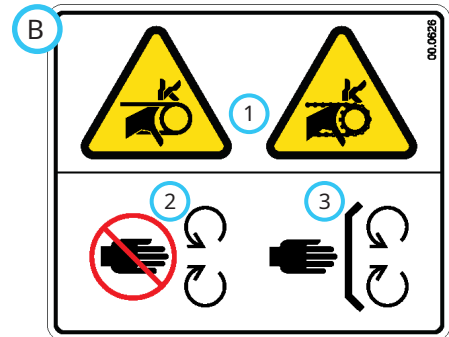

1. Fingers or hand entanglement hazard.
2. Stay away from moving parts.
3. Keep all guards and shields in place.

# SAFETY

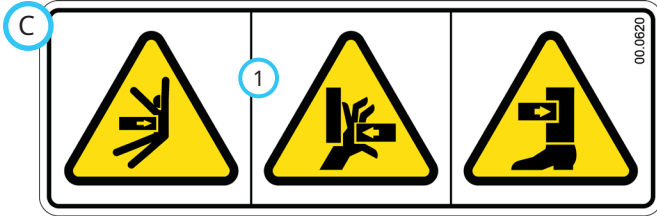

1. Pinching or crushing hazard.

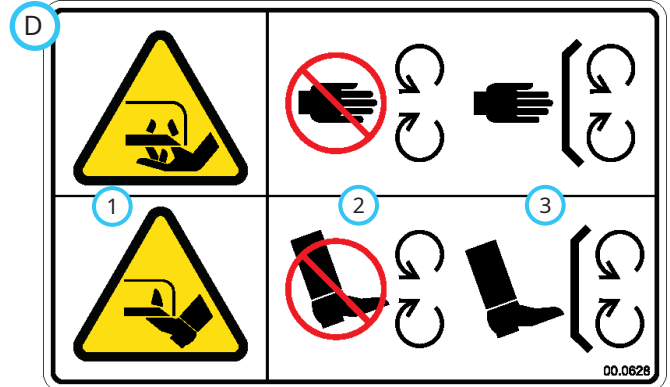

1. Cutting or dismemberment hazard of hand or foot - mower blade.  
 2. Stay away from moving parts.  
 3. Keep all guards and shields in place.

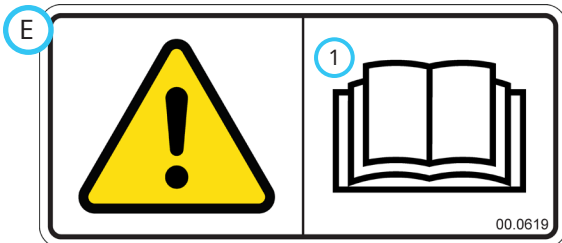

1. Read the operator's manual.

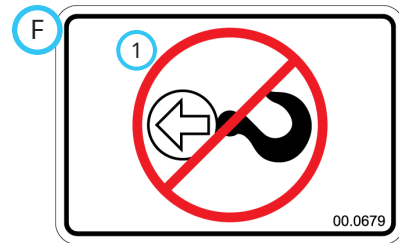

1. Not a tow point.

Decal	Description	Part Number	Quantity
A	Shield Missing	00.0625	1
B	Entanglement Hazard	00.0626	1
C	Pinching or Crushing Hazard	00.0620	1
D	Cutting Hazard - Mower Blade	00.0628	2
E	Read Operator's Manual	00.0619	1
F	Not A Tow Point	00.0679	1

# OPERATIONAL CONTROLS

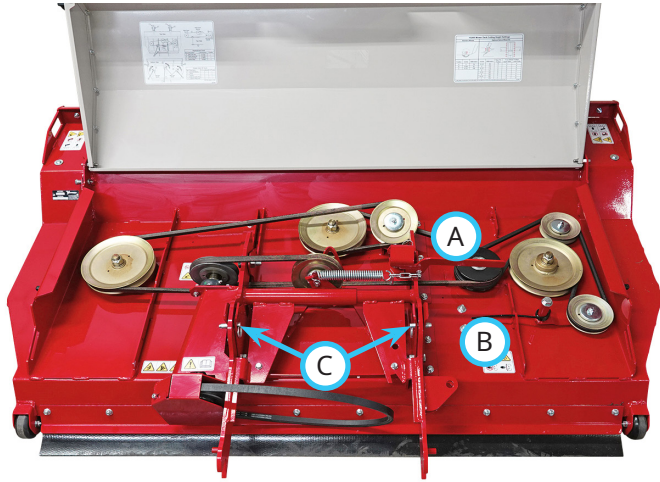

- A. Main Belt Tension Handle
- B. Right Belt Tension Spring
- C. Hitch Arm Pins

## Main Belt Tension Handle

The main deck belt tension handle (A) is used to release or apply tension to the main deck belt. The main belt tension handle must be released in order to flip the deck up to the service position.

Remove the ball pin (1) from the main belt tension handle and rotate the handle 180 degrees to release the belt tension.

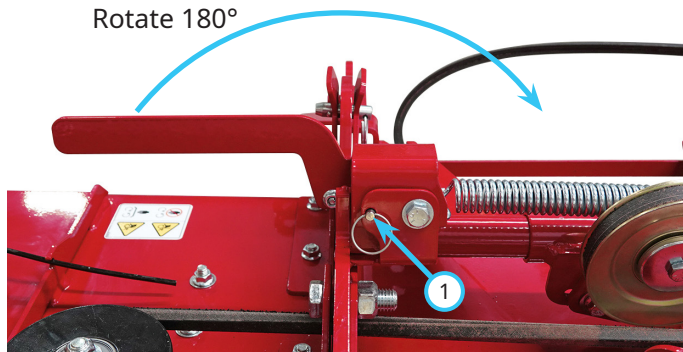

## Right Belt Tension Spring

The right belt tension spring (B) is used to release or apply tension to the right spindle deck belt.

## Hitch Arm Pins

The hitch arm pins (C) are used to set the rear height of the mower deck and to set the hitch arm height for attaching to the power unit. The pins are also used to secure the deck in the flipped up (service) position.

## Primary SDLA Control Lever

Pull the power unit's primary SDLA lever\* to the left to raise the mower deck. Push the lever to the right to lower the mower deck. The primary SDLA lever must be in the float (detent) position during operation of the mower.

## Secondary SDLA Control Lever

The power unit's secondary SDLA lever controls the optional hydraulic deck flip up kit. Pull the lever to the left to flip the deck up to the service position. Push the lever to the right to lower the deck back down to the operating position.

## Weight Transfer

Terrain and ground conditions may affect the appropriate setting for the power unit's weight transfer system. In most cases, the weight transfer system\* should be set from 1/2 to 3/4 of maximum capacity.

\*Refer to power unit operator's manual for operation of power unit controls.



# GENERAL OPERATION

## Daily Inspection

### **⚠ WARNING**

Always engage the parking brake, shut off the power unit engine, remove the ignition key, and ensure that all moving parts have come to a complete stop before inspecting the components, or attempting any repair or adjustment.

1. Park the machine on a level surface, with the engine shut off and all fluids cold.
2. Perform a visual inspection of both the power unit and the attachment. Look for loose or missing hardware, damaged components, or signs of wear.
3. If equipped with a hydraulic flip up kit, inspect the hydraulic hoses and the hydraulic fittings to ensure tight, leak free connections.
4. Inspect the belts for damage or excessive wear. Refer to the Belt Inspection section of this manual.
5. Inspect the mower blades and the mower blade mounting bolts. The blades should be sharp and securely fastened. Service as required.

## Attaching

1. Install the hitch arm pins in position G.
2. Drive the power unit slowly forward into the hitch arms of the attachment. Align the lift arms of the power unit with the attachment hitch arms by raising or lowering the front hitch and complete the engagement.
3. Once completely engaged, close the front hitch locking lever.\*
4. Engage the parking brake\* and shut off the engine.
5. Place the attachment belt onto the PTO drive pulley on the power unit. Ensure the belt is properly seated in each pulley.
6. Engage the PTO belt tensioner rod.
7. If equipped with a hydraulic flip up kit, wipe the hose ends clean and connect to the power unit's hydraulic quick couplers. If equipped, connect the hoses and the quick couplers so the colored indicators are paired together (red to red, etc.).
8. Move the hitch arm pins to the desired cutting height position.

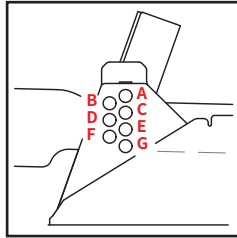

## Detaching

1. Park the power unit on a level surface and engage the parking brake.\*
2. Move the hitch arm pins to position G.
3. Lower the attachment to the ground.
4. Shut off the power unit engine.
5. Disengage the PTO belt tensioner rod.
6. Remove the attachment belt from the PTO drive pulley of the power unit.
7. If equipped with a hydraulic flip up kit, disconnect the hydraulic quick couplers from the power unit and store the hose ends in the top frame holes on the attachment.
8. Disengage the front hitch locking lever.\*
9. Restart the power unit and slowly back away from the attachment. A side to side movement of the steering wheel may aid in disengagement.

## Operating Procedure

Before operation, perform the daily inspection, confirm that the mower is set at the desired cutting height, and that the hitch arm pins are in the proper position. Confirm that the power unit's weight transfer system is set properly.

Inspect the mowing area and remove rocks, sticks, and any other objects that could be thrown by the machine or become entangled in the blades.

Lower the mower deck to the ground and place the power unit's primary SDLA lever in the float position.

With the power unit engine running between 2,000 and 3,000 RPM, engage the PTO switch, then adjust the throttle to the desired engine RPM.

Begin forward motion in the desired mowing path. Avoid obstacles and remove debris as necessary. When the edge of the mowing area is reached, turn the power unit and the mower around and align for the next pass.

\*Refer to power unit operator's manual for operation of power unit controls.

# GENERAL OPERATION

## Transport of the Attachment

Transport the attachment with the power unit front hitch and attachment fully raised to reduce wear of the equipment. Travel slowly when transporting over undulating and rough surfaces to maintain control of the power unit and to reduce the shock to the power unit and the attachment. Always disengage the power unit PTO before transporting the attachment.

## Cutting Height Adjustment (Fixed Wheels)

1. Park the power unit and mower deck on a smooth, level surface and engage the parking brake.

### **⚠ WARNING**

Accidental lowering of the mower deck could trap a person or appendage.

When making adjustments with the mower deck in the raised position, the mower deck must be supported securely with blocks or jack stands.

2. Raise the front of the mower deck and support the mower deck with blocks or jack stands.
3. Shut off the engine and remove the ignition key.
4. Remove the wheel mounting bolt (A) and move the wheel to the desired position.

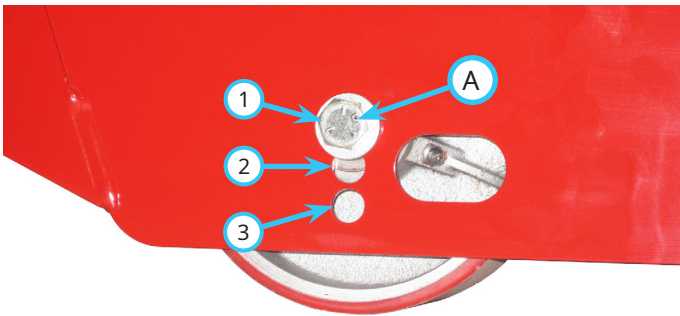

Wheel Position	Millimeters	Inches
1	76	3
2	92	3-5/8
3	108	4-1/4

5. Reinstall the wheel mounting bolt and torque to 102 NM (75 ft-lbs).
6. Repeat for the wheel on the opposite side of the mower deck.
7. Lower the mower deck to the ground and place the primary SDLA lever into the float position.

8. Measure the distance from the ground surface to the top surface of the mower deck at the locations shown (B & C). If the measurement at the rear location is less than the front measurement or more than 6.5 mm (1/4 inch) greater than the front measurement, the hitch arm pins will need to be repositioned.

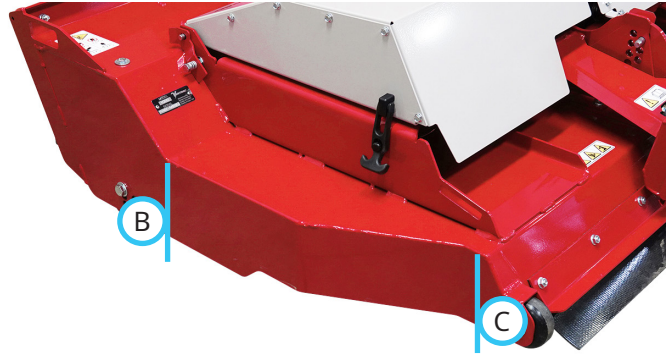

9. To lower the rear of the mower deck, move the hitch arm pins to a higher position. To raise the rear of the mower deck, move the hitch arm pins to a lower position.
10. After changing the hitch arm pin positions, re-check the mower deck to confirm it is level.

# GENERAL OPERATION

## Cutting Height Adjustment (Swivel Wheels)

1. Park the power unit and mower deck on a smooth, level surface and engage the parking brake.

### **WARNING**

Accidental lowering of the mower deck could trap a person or appendage.

When making adjustments with the mower deck in the raised position, the mower deck must be supported securely with blocks or jack stands.

2. Raise the front of the mower deck and support the mower deck with blocks or jack stands.
3. Shut off the engine and remove the ignition key.
4. Use the chart to determine the positions for the front wheels and the hitch arm pins for the desired cutting height.

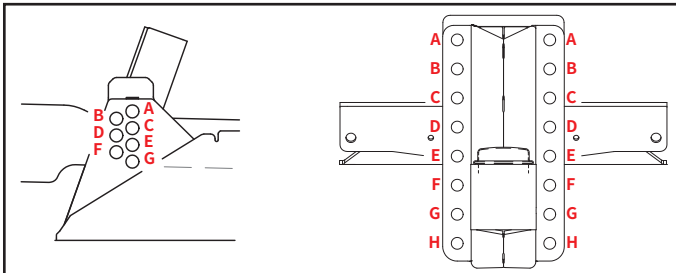

Inches	Millimeters	Hitch Arm Pin Position	Front Wheel Position	
			Upper Bolts	Lower Bolts
3-1/2	89	B	E	H
4	102	C	E	H
4-1/2	114	C	D	G
5	127	D	D	G
5-1/2	140	D	C	F
6	152	E	C	F
6-1/2	165	F	B	E
7	178	F	A	D

\*Cutting heights are approximate and may vary depending on model of power unit, style of tire, etc.

5. Place the hitch arm pins for the right and left hitch arms into the desired cutting height position.
6. Remove the four bolts that fasten the swivel wheel frame to the mounting bracket.
7. Move the swivel wheel frame to the desired cutting height position and reinstall the four bolts. Torque to 42 Nm (31 ft-lbs).
8. Repeat for the front wheel on the opposite side of the mower deck.

## Swivel Wheel Outer Position

The swivel wheels can be positioned closer to the outer edges of the mower deck.

1. Remove the carriage bolt (A) and nut from the front belting clamp and the bolt (B), washer (C), and nut from the slot in the deck frame.

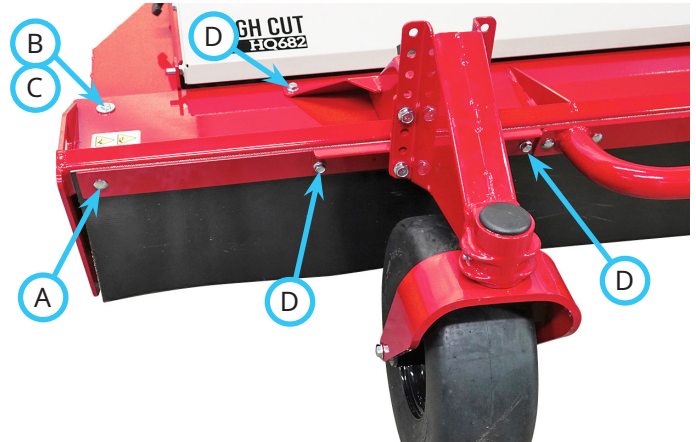

2. Remove the four flange bolts (D) and nuts from the wheel mount frame.
3. Move the wheel mount frame to the two outside sets of mounting holes and reinstall using the four flange bolts (D) and nuts. Torque to 24 Nm (210 in-lbs).

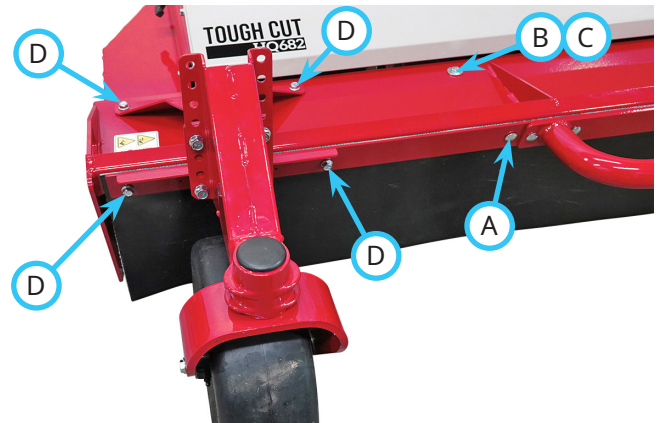

4. Reinstall the carriage bolt (A) and nut in the front belting clamp. Torque to 24 Nm (210 in-lbs).
5. Reinstall the bolt (B), washer (C), and nut into the inner slot in the deck frame. Torque to 24 Nm (210 in-lbs).
6. Repeat for the other swivel wheel.

# SERVICE

## ⚠ WARNING

Always engage the parking brake, shut off the power unit engine, remove the ignition key, and ensure that all moving parts have come to a complete stop before inspecting the components, or attempting any repair or adjustment.

## ATTENTION

If any component requires replacement, use only original Ventrac replacement parts.

### Cleaning and General Maintenance

For best results, and to maintain the finish of the mower deck, clean or wash the mower to remove accumulated clippings, leaves, and dirt when the job is finished. Refer to the Deck Flip Up Procedure to access the underside of the deck.

If washing the mower deck, do not spray directly into the bearings or seals. After washing, it is important to run the mower so that water does not reside on the seals or bearings for the drive system. When washing is complete, return the deck to the operating position. Move the power unit and mower to a clean, debris-free location and activate the PTO for 30 seconds to remove any standing water.

### Deck Cover Removal and Installation

1. Unfasten the rubber latches at the rear of the deck cover.
2. Open the deck cover.
3. From the front of the mower deck, pull the latch plate (A) out away from the hinge.
4. Pull the left side of the deck forward out of the hinge bracket.
5. Slide the deck cover to the left to remove the right hinge pin from the hinge bracket.
6. To reinstall the deck cover, insert the right hinge pin into the hole in the hinge bracket.
7. Align the left hinge pin with the slot in the hinge bracket and push back until the latch plate snaps over the pin to secure in place.

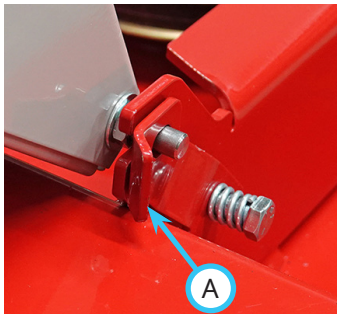

### Deck Flip Up Procedure (Service Position) Manual Flip Up Procedure

1. Park the power unit and mower on a smooth, level surface.
2. Engage the parking brake, shut off the engine, and remove the ignition key.
3. Remove the deck cover.
4. Remove the ball pin from the main belt tension handle and rotate the handle 180 degrees to release the main deck belt tension.
5. Remove the hitch arm pins from the hitch arm mounting brackets.
6. Restart the engine and raise the power unit front hitch to its highest position.
7. Shut off the engine and remove the ignition key.
8. Lift the front of the mower deck up to a near vertical position and install the hitch arm pins (A) in the front mounting holes to lock the deck in the upright position.

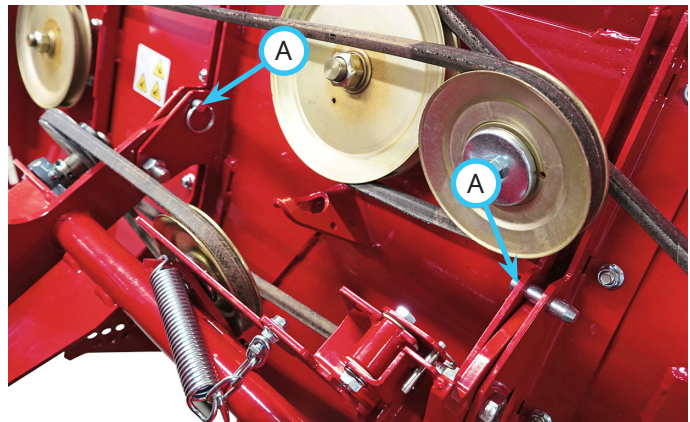

9. To return the deck to the operating position, remove the hitch arm pins (A) from the front of the hitch arms and rotate the mower deck to the operating position.
10. Lower the mower deck to the ground.
11. Reinstall the hitch arm pins into the hitch arm mounting brackets.
12. Ensure the belt is properly seated in the pulley grooves, rotate the main deck belt tension handle 180 degrees to engage belt tension, and secure with the ball pin.
13. Reinstall the deck cover.

# SERVICE

## Optional Hydraulic Flip Up Procedure

1. Park the power unit and mower on a smooth, level surface.
2. Engage the parking brake, shut off the engine, and remove the ignition key.
3. Remove the deck cover.
4. Remove the ball pin from the main belt tension handle and rotate the handle 180 degrees to release the main deck belt tension.
5. Remove the hitch arm pins from the hitch arm mounting brackets.
6. Return to the operator's seat, start the engine, and raise the power unit front hitch to its highest position.
7. Pull the secondary SDLA lever to the left and hold until the deck stops moving at a near vertical position.
8. Shut off the engine and remove the ignition key.
9. Install the hitch arm pins (A) in the front mounting holes to lock the deck in the upright position.

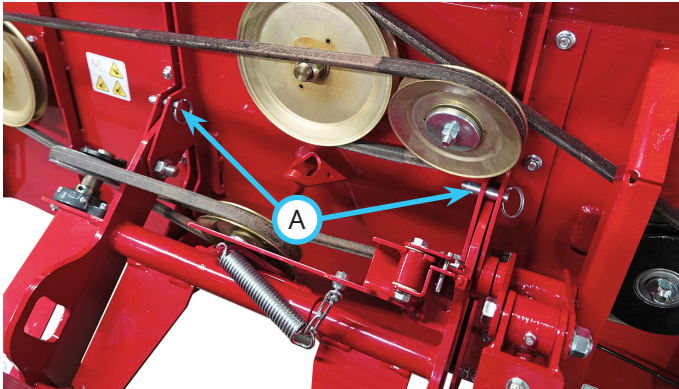

10. To return the deck to the operating position, remove the hitch arm pins (A) from the hitch arm mounting brackets, return to the operator's seat, start the engine, and lower the deck to the operating position by pushing the secondary SDLA lever to the right. NOTE: if the front hitch lowers due to hydraulic drift, it may be necessary to start the engine and raise the front hitch before removing the hitch arm pins.
11. Lower the mower deck to the ground.
12. Shut off the engine and remove the ignition key.
13. Reinstall the hitch arm pins into the hitch arm mounting brackets.
14. Ensure the belt is properly seated in the pulley grooves, rotate the main deck belt tension handle 180 degrees to engage belt tension, and secure with the ball pin.
15. Reinstall the deck cover.

## Mower Blade Inspection/Replacement

### ⚠ CAUTION

The mower blades may be sharp. Always wear heavy gloves when working with the mower blades.

1. Rotate the mower deck up to the service position.
2. Inspect the mower blades to ensure the cutting edges are sharp. If the blades are dull or damaged, they must be removed and sharpened or replaced.
3. Place a short piece of 2 x 4 wood between the end of the blade and an appropriate structural part of the mower deck to prevent the blade from rotating.
4. Refer to the following diagram (shown from in front of the mower with the deck flipped up to the service position) to determine the left and right hand spindles and the bolt removal direction.

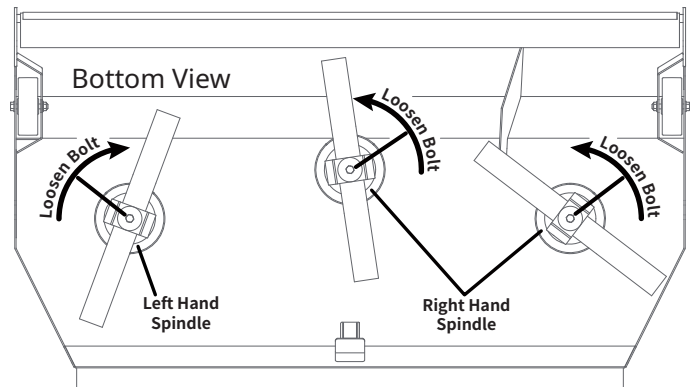

5. Remove the blades for sharpening or replacement.
6. When installing a blade, the wood block must be placed in position to prevent blade rotation when tightening the blade bolt.
7. Torque the blade bolts to 108 Nm (80 ft-lbs).

## Mower Blade Sharpening

The mower blades should be sharpened and balanced by a professional. Maintain the balance, the same bevel, and the length of the sharpened surface.

# SERVICE

## Belt Inspection

Inspecting the drive belts of the attachment can prevent sudden belt failure by finding problems before they cause a belt to break.

Typical wear on a drive belt may result in the conditions shown in the diagram. If any of these conditions occur, the drive belt will require replacement.

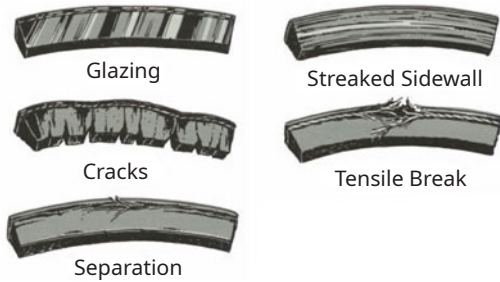

## Attachment Drive Belt Replacement

1. Detach the mower deck from the power unit.
2. Remove the drive pulley shield (A).
3. Remove the old attachment belt and install the new belt onto the pulley.
4. Reinstall the drive pulley shield. Torque the nut to 11 Nm (100 in-lbs).

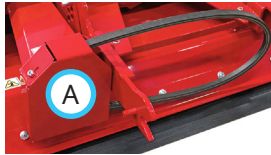

## Main Deck Belt Replacement

1. Detach the mower deck from the power unit.
2. Open the deck cover.
3. Remove the ball pin from the main belt tension handle and rotate the handle 180 degrees to release the main deck belt tension.
4. Remove the hitch arm pins from the hitch arm mounting brackets.
5. Remove the belt from the belt tensioner pulley and slide the loop of the belt over the end of the left hitch arm so that the belt is looped around the left hitch arm mounting brackets.

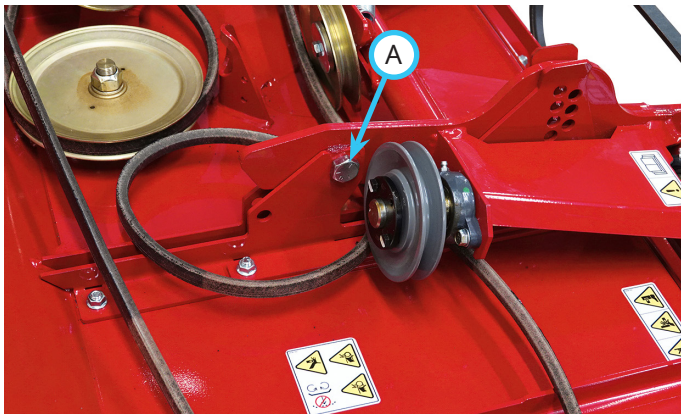

6. Remove the mounting bolts (A) from both the left and right hitch arms and lift the hitch arm assem-

bly out of the front mounting brackets.

7. Remove the old belt from the spindle pulleys.
8. Install the new belt onto the spindle pulleys as shown in the belt diagram.

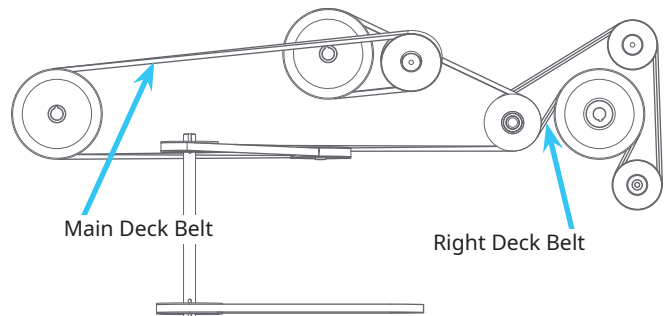

9. Loop the belt around the left hitch arm mounting bracket as shown in the removal step.
10. Reinstall the hitch arm assembly into the mounting brackets and torque the bolts to 205 Nm (151 ft-lbs).
11. Place the belt loop onto the drive shaft pulley and the belt tensioner pulley.
12. Check to ensure the belt is routed properly and seated in the groove of each pulley.
13. Rotate the main deck belt tension handle 180 degrees to engage belt tension, and secure with the ball pin.
14. Reinstall the two rear ball pins at the top of the hitch arms.
15. Close and latch the deck cover.

# SERVICE

## Right Deck Belt Replacement

1. Detach the mower deck from the power unit.
2. Open the deck cover.
3. Remove the ball pin from the main belt tension handle and rotate the handle 180 degrees to release the main deck belt tension.
4. Remove the main deck belt from the top groove of the double pulley that drives the right deck belt.
5. Release the right deck belt tensioning spring (A).

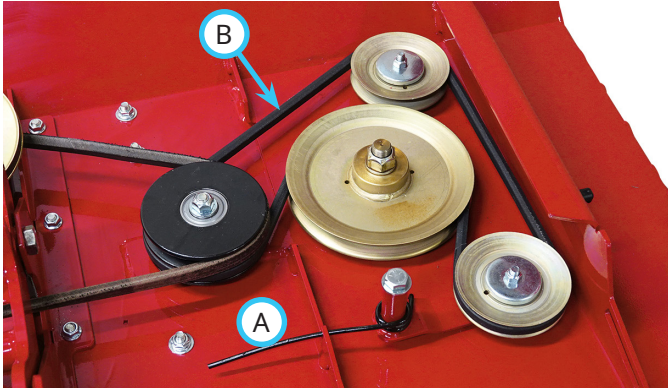

6. Remove the old right deck belt (B).
7. Install the new right deck belt onto the pulleys as shown in the belt diagram. The right deck belt is installed in the bottom groove of the double pulley.

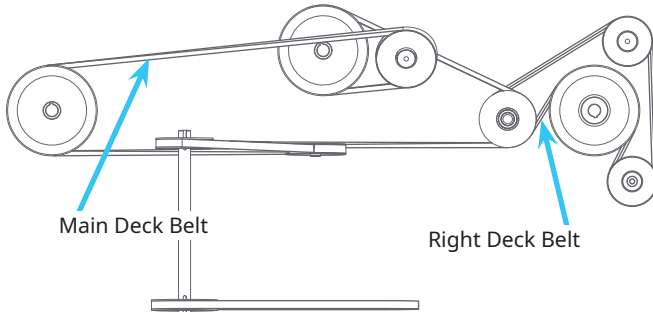

8. Engage the right deck belt tensioning spring.
9. Place the main deck belt into the top groove of the double pulley and ensure the belt is seated in the groove of each pulley.
10. Rotate the main deck belt tension handle 180 degrees to engage belt tension, and secure with the ball pin.
11. Close and latch the deck cover.

## Main Deck Belt Tension Adjustment

If the main deck belt slips during normal mowing operation, the belt tension needs to be adjusted.

1. Open the deck cover.
2. Remove the ball pin from the main belt tension handle and rotate the handle 180 degrees to release the main deck belt tension.
3. Move the extension spring hook (A) into the next chain link (B) closer to the main belt tension handle.

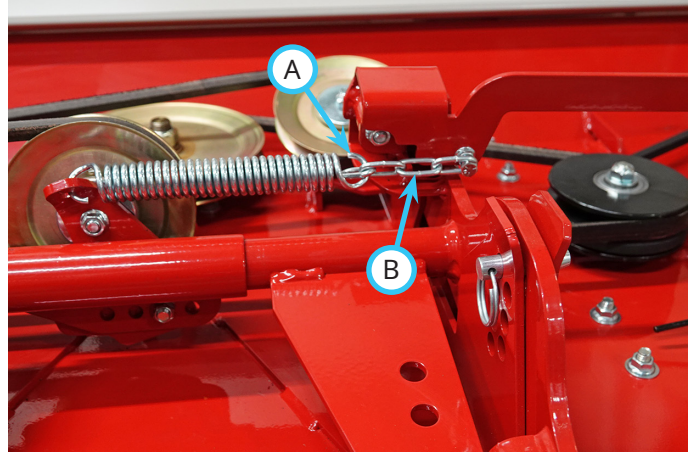

4. Rotate the main deck belt tension handle 180 degrees to engage belt tension, and secure with the ball pin.
5. Close and latch the deck cover.

# SERVICE

## Lubrication Locations

Lubrication is required at the following locations using a lithium complex NLGI #2 grease.

Wipe the grease fittings clean before applying grease to the grease fittings.

Refer to the maintenance schedule for service intervals and the amount of grease.

1. Grease the fixed wheels (right and left).

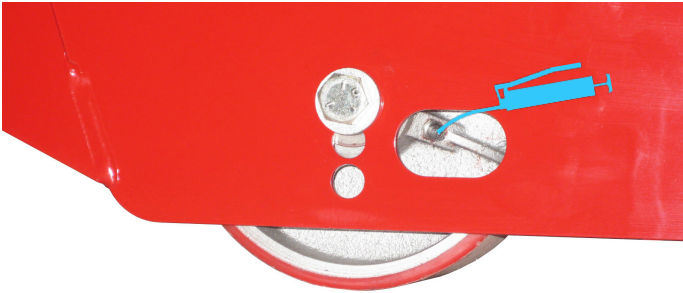

2. Grease the caster wheel axles and pivots.



3. Grease the drive shaft bearings.

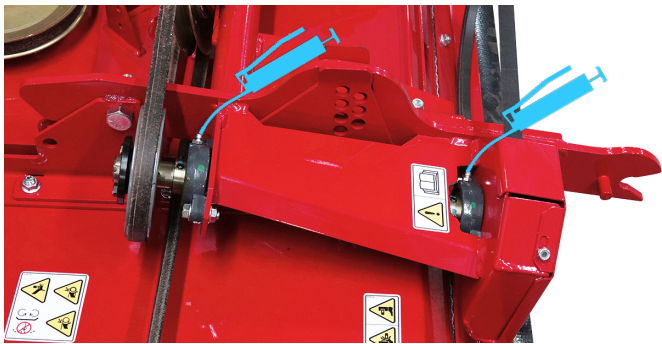

4. Grease the spindles.

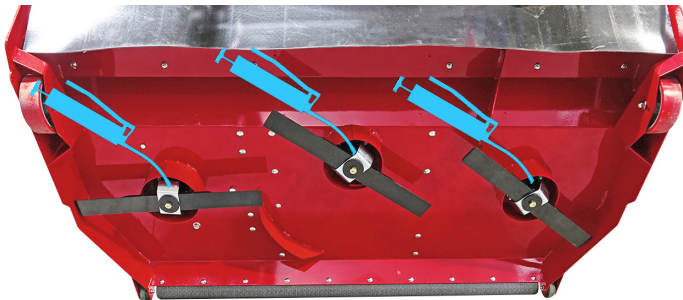

5. If equipped with a hydraulic flip up kit, grease the cylinder ends and the flip up rocker bracket.

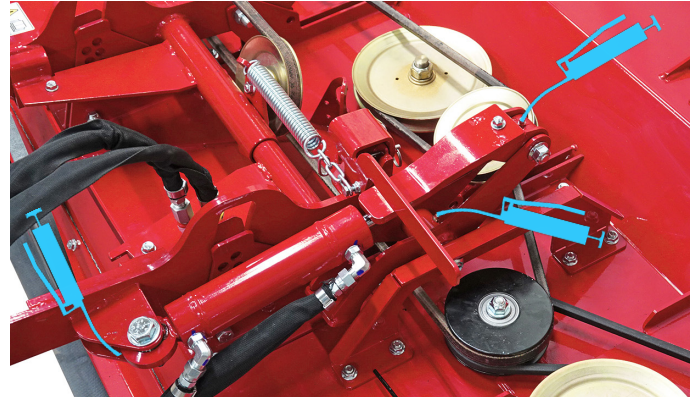

## Storage

### Preparing the Attachment for Storage

1. Clean the attachment to remove accumulated clippings, leaves, and dirt.
2. Inspect for loose or missing hardware, damaged components, or signs of wear. Repair or replace any damaged or worn components.
3. Inspect the belts, the spindles, and the mower blades. Repair or replace any damaged or worn components.
4. Inspect the safety decals. Replace any decals that are faded, illegible, or missing.
5. Apply grease to all grease points and wipe off any excess grease.
6. If the mower deck is equipped with a hydraulic flip up kit, inspect the hydraulic hoses for damage or wear. Inspect the hydraulic hoses and fittings to ensure tight, leak-free connections.
7. Inspect the painted components for chips, scratches, or rust. Clean and touch up the surfaces as needed.

### Removing the Attachment from Storage

1. Clean the attachment to remove any accumulated dust or debris.
2. Inspect the attachment as instructed in the Daily Inspection section of this manual.
3. Test the attachment to ensure that all the components are working properly.



# SERVICE

## Maintenance Schedule

	# of locations	# of pumps	As Needed	Daily	At 50 hours	At 100 hours	At 150 hours	At 200 hours	At 250 hours	At 300 hours	At 350 hours	At 400 hours	At 450 hours	At 500 hours	At 550 hours	At 600 hours	At 650 hours	At 700 hours	At 750 hours	At 800 hours	At 850 hours	At 900 hours	At 950 hours	At 1,000 hours	Yearly
Grease and Lubrication: See Lubrication Section																									
Drive Shaft Bearing	2	1			✓	✓	✓	✓	✓	✓	✓	✓	✓	✓	✓	✓	✓	✓	✓	✓	✓	✓	✓	✓	✓
Fixed Wheel	2	1			✓	✓	✓	✓	✓	✓	✓	✓	✓	✓	✓	✓	✓	✓	✓	✓	✓	✓	✓	✓	✓
Swivel Wheel Caster	2	1			✓	✓	✓	✓	✓	✓	✓	✓	✓	✓	✓	✓	✓	✓	✓	✓	✓	✓	✓	✓	✓
Swivel Wheel Axle	2	^	**		✓	✓	✓	✓	✓	✓	✓	✓	✓	✓	✓	✓	✓	✓	✓	✓	✓	✓	✓	✓	✓
Spindle	3	3			✓	✓	✓	✓	✓	✓	✓	✓	✓	✓	✓	✓	✓	✓	✓	✓	✓	✓	✓	✓	✓
Hydraulic Flip Up Cylinder Ends	2	^			✓	✓	✓	✓	✓	✓	✓	✓	✓	✓	✓	✓	✓	✓	✓	✓	✓	✓	✓	✓	✓
Hydraulic Flip Up Rocker Bracket	2	^			✓	✓	✓	✓	✓	✓	✓	✓	✓	✓	✓	✓	✓	✓	✓	✓	✓	✓	✓	✓	✓
Inspection																									
Inspect for Loose, Missing, or Worn Components				✓																					
Inspect the Belts and Pulleys				✓																					
Inspect the Blades and Blade Mounting Bolts Torque to 108 Nm (80 ft-lbs)				✓																					
Check the Hitch Pivot Bolts (Torque to 205 Nm (151 ft-lbs))					✓		✓			✓		✓		✓		✓		✓		✓		✓		✓	
Inspect the Safety Decals				✓																					
^Grease until fresh grease is visible.																									
**Operation in severe conditions may require more frequent service intervals.																									

## Maintenance Checklist

	# of locations	# of pumps	As Needed	Daily	At 50 hours	At 100 hours	At 150 hours	At 200 hours	At 250 hours	At 300 hours	At 350 hours	At 400 hours	At 450 hours	At 500 hours	At 550 hours	At 600 hours	At 650 hours	At 700 hours	At 750 hours	At 800 hours	At 850 hours	At 900 hours	At 950 hours	At 1,000 hours	Yearly
Grease and Lubrication: See Lubrication Section																									
Drive Shaft Bearing	2	1																							
Fixed Wheel	2	1																							
Swivel Wheel Caster	2	1																							
Swivel Wheel Axle	2	^	**																						
Spindle	3	3																							
Hydraulic Flip Up Cylinder Ends	2	^																							
Hydraulic Flip Up Rocker Bracket	2	^																							
Inspection																									
Inspect for Loose, Missing, or Worn Components																									
Inspect the Belts and Pulleys																									
Inspect the Blades and Blade Mounting Bolts Torque to 108 Nm (80 ft-lbs)																									
Check the Hitch Pivot Bolts (Torque to 205 Nm (151 ft-lbs))																									
Inspect the Safety Decals																									
^Grease until fresh grease is visible.																									
**Operation in severe conditions may require more frequent service intervals.																									

# SPECIFICATIONS

---

## Dimensions

Overall Height . . . . .	56 cm (22 inches)
Overall Length . . . . .	150 cm (59 inches)
Overall Width . . . . .	175 cm (69 inches)
Weight . . . . .	215.5 kg (475 pounds)
Cutting Width . . . . .	173 cm (68 inches)
Cutting Height Range (fixed wheels) . . . . .	76 - 108 mm (3 - 4-1/4 inches)
Cutting Height Range (front swivel wheels) . . . . .	89 - 178 mm (3-1/2 - 7 inches)

## Features

- Heavy duty deck construction.
- Rear discharge deck design.
- Flip up deck design.
- Heavy duty mower blades.

Visit [ventrac.com/manuals](http://ventrac.com/manuals)  
for the latest version of this operator's manual.  
A downloadable parts manual is also available.

[View all manuals](#)

