

Operator's Manual

4520P

Standard Unit - Serial Number 4520P-AR01001 --
California Compliant - Serial Number 4520P-AT01001 --





500 Venture Drive
Orrville, OH 44667
www.ventrac.com

View all manuals



Visit ventrac.com/manuals for the latest version of this operator's manual.

A downloadable parts manual is also available.

To the Owner Contact Information and Product Identification

If you need to contact an authorized Ventrac dealer for information on servicing your product, always provide the product model and serial numbers.

Please fill in the following information for future reference. See the picture(s) below to find the location of the identification numbers. Record them in the spaces provided.

Date of Purchase: _____

Dealer: _____

Dealer Address: _____

Dealer Phone Number: _____

Dealer Fax Number: _____

Model # (A): _____

Serial # (B): _____

Engine Serial # (C) _____

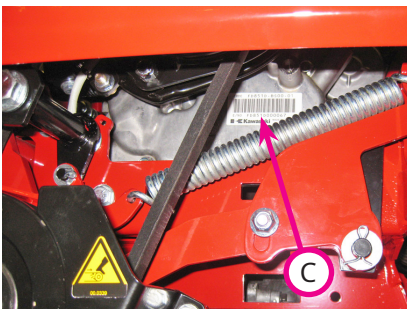
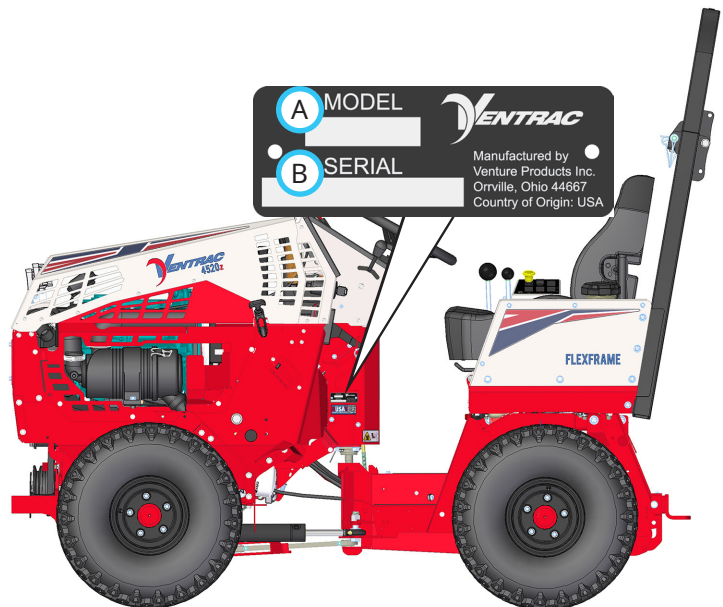

Ventrac Products Inc. reserves the right to make changes in design or specifications without obligation to make like changes on previously manufactured products.

TABLE OF CONTENTS

INTRODUCTION	PAGE 7
Product Description	7
Why Do I Need an Operator’s Manual?	7
Using Your Manual	8
Manual Glossary	8
SAFETY	PAGE 9
General Safety Procedures	9
Training Required	9
Requirements for Personal Protective Equipment (PPE)	9
Operation Safety.	9
Keep Riders Off	11
Operating On Slopes	11
Truck Or Trailer Transport	12
Maintenance	12
Fuel Safety	13
Hydraulic Safety	14
Roll Over Protective Structure (ROPS).	15
Operator Access System	15
California Proposition 65	16
Operator Safety Interlock System	16
Safety Decals	18
OPERATIONAL CONTROLS	PAGE 22
Standard Control Locations	22
Optional Accessory Control Locations.	23
Information Cluster Gauge (A).	24
Warning Alarm (B).	25
Ignition Switch (C).	25
Throttle Lever (D)	25
High/Low Shift Lever (E).	25
Steering Wheel (F).	26
Parking Brake (G)	26
Front Hitch Latch Lever (H)	26
Neutral Assist Lever (J)	26
Auxiliary Hydraulic Quick Couplers (K)	26
PTO Belt Tensioner Rod (L)	27
SDLA Control Lever (M & N)	27
Power Take Off (PTO) Switch (O)	27
Headlight Switch (P).	27
USB Receptacle (Q)	27
Seat Slide Lever (R)	27
Fuel Shut-off Valve (S).	28
Circuit Breaker & Battery Disconnect (T)	28
Seat Prop Plate (U).	28
Seat Strap Latch (V)	28
Weight Transfer Traction Control Select Lever (W).	28
Work Light Switch (AA)	29
Strobe Light Switch (BB)	29
Directional Signal Switch (CC)	29

TABLE OF CONTENTS

OPERATIONAL CONTROLS (Continued)

Hazard Flasher Switch (DD)	29
Horn Switch (EE)	29
12 Volt Front Switches and 4-Pin Socket (FF, GG, and HH)	29
Dual Front Hydraulic Auxiliary Switch (II)	29
Dual Front Hydraulic Auxiliary Valve (JJ)	29
12 Volt Rear Switches and 4-Pin Socket (KK, LL, and MM)	30
Slope Indicator Gauge (NN)	30
Foot Pedal (OO)	30
3 Point Hitch & Rear Auxiliary Control Handles (PP, QQ, and RR)	31
Rear Auxiliary Control Handles (QQ and RR)	31
Rear Auxiliary Quick Couplers (SS)	31
Back Up Alarm (TT)	31
Seat Slide Lever (UU)	32
Lumbar Support Knob (VV)	32
Backrest Angle Lever (WW)	32
Weight Adjustment Lever (XX)	32
Heat Switch (YY)	32
Optional Armrest Angle Knob (ZZ)	32
Front Hitch Valve (BA)	32

GENERAL OPERATION

PAGE 33

Daily Inspection	33
Starting the Engine	33
Forward and Reverse	34
Stopping the Power Unit	34
Shutting Off the Engine	34
Attaching	35
Detaching	35
Operating Attachments	35
Front Hitch	35
PTO Drive Belt and Pulley	35
Front Auxiliary Couplers	36
Weight Transfer	36
High/Low Range	36
Turning Radius	37
Roll-Over Protection System	37
3 Point Hitch (Optional Accessory)	38
12 Volt 4-Pin Auxiliary Sockets (Optional Accessory)	38
Directional/Hazard Flasher Operation (Optional Accessory)	38
Operating On Slopes	39
Slope Gauge Settings and Operation	40
Audible and Visual Alerts (70.4140 Gauge)	42
70.4140 Slope Gauge Calibration	42
Operation in Water, Mud, Snow, or Ice	42
Towing or Pushing the Power Unit	42

TABLE OF CONTENTS

SERVICE	PAGE 43
Service and General Maintenance	43
Cleaning and Appearance Care	43
Service Access Points	44
Lubrication Locations	44
Checking the Hydraulic Oil Level.	45
Checking the Rear Transaxle Oil	46
Changing the Hydraulic Oil Filters.	46
Changing the Hydraulic Oil.	47
Changing the Rear Transaxle Differential Oil.	48
Servicing the Closed Loop Hydrostatic Drive Circuit.	48
Servicing the Hydraulic Cooler	48
Checking the Engine RPM	48
Checking the Engine Oil Level	49
Changing the Engine Oil and Filter	49
Changing the Air Filter Elements	50
Filling the Fuel Tank	51
Changing the In-line Fuel Filter	51
Priming the Fuel System	51
Cleaning the Engine Compartment and Engine	51
Servicing the Cooling System	52
Checking the Cooling System	52
Cleaning the Radiator and Screen.	53
Draining the Cooling System.	53
Flushing the Cooling System.	53
Servicing the Battery	54
Removing the Battery.	54
Installing the Battery	54
Cleaning the Battery and Terminals.	55
Charging the Battery	55
Jump Starting Procedure	55
TCS (Tractor Control System) Explanation	56
Replacing Fuses (Power Relay Module)	56
Replacing Fuses (Front Fuse Panel)	57
Replacing Fuses (Rear Fuse Panel).	57
Replacing Fuses (Engine)	58
Switching the Speedometer (mph or km/h)	58
Replacing the Head Lights	58
Replacing the Tail Lights	58
Replacing the Work Lights	58
Replacing the Turn Signal Lights.	58
Replacing the Strobe Light(s).	58
Changing the ROPS Strobe Light Flasher Mode	58
PTO Belt Inspection	59
PTO Belt Tension Adjustment	60
PTO Belt Replacement	60
Clutch Air Gap Inspection and Adjustment.	61
Wheel Removal and Installation	61
Outer Dual Wheel Removal and Installation	62
Tire Pressure	62

TABLE OF CONTENTS

SERVICE (Continued)

ROPS and Seat Belt Inspection	63
Parking Brake Inspection and Adjustment	63
Neutral Adjustment	64
Neutral Switch Adjustment	65
Storage	65
Maintenance Schedule	67
Maintenance Checklist	68
Maintenance Log	69

TROUBLESHOOTING

PAGE 71

Engine	71
Electrical	72
Hydraulic	73
Power Unit	74

SPECIFICATIONS

PAGE 75

Engine	75
Electrical	75
Power Train	75
Controls and Instrument Panel	75
Other Features	75
Dimensions	76
Fluid Capacities and Specifications	76

INTRODUCTION



Venture Products Inc. is pleased to provide you with your new Ventrac power unit! We hope that Ventrac equipment will provide you with a ONE Tractor Solution.

Please visit our website, or contact your authorized Ventrac dealer for a complete list of items available for your new power unit.

Product Description

The Ventrac 4520 tractor combines all wheel drive and an articulating chassis with a low center of gravity to provide superior traction, braking, stability, and security on tough terrain and slopes without disturbing turf when turning. The attachment is placed out in front in a natural view, offering greater precision, as well as maximum protection for the operator.

Ventrac's SDLA control, located next to the operator, allows for easy control of Speed, Direction, Lift, and Auxiliary functions with one hand.

Standard features include:

- a fold down roll bar.
- a wiring harness that is pre-wired for optional accessories.
- an electronic information gauge that includes a tachometer, speedometer, fuel gauge, hour meter, and temperature gauge. The information gauge also includes warning lights and alarms for the engine coolant temperature, hydraulic oil temperature, low voltage, and low engine oil pressure, along with a parking brake indicator.
- a complete electrical system circuit breaker and battery disconnect.
- an automotive pull style parking brake.
- a hydraulic oil cooler with a thermostatically controlled fan.

Why Do I Need an Operator's Manual?

This manual has been created to help you gain the important knowledge of what is needed to safely operate and maintain your machine, and to avoid injury and product damage. It is divided into chapters for convenient reference of the appropriate information.

You must read and understand the operator's manual for each piece of Ventrac equipment you own. Reading the operator's manual will help you become familiar with each specific piece of equipment. If this manual becomes damaged or unreadable, it should be replaced immediately. Contact your local Ventrac dealer for a replacement.

When using a Ventrac attachment, be sure to read and follow the safety and operating instructions of both the power unit and the attachment being used to ensure the safest operation possible.

The information in this manual provides the operator with the safest procedures to operate the machine while getting the maximum use out of the unit. Failure to follow the safety precautions listed in this manual may result in personal injury and/or damage to the equipment.

INTRODUCTION

Using Your Manual

This manual identifies potential hazards and safety concerns to help you, as well as others, avoid personal injury and/or damage to the equipment.

Safety should always be the first priority when working on or operating equipment. Accidents are more likely to occur when proper operating procedures are not followed or inexperienced operators are involved.

SYMBOL DEFINITIONS



This symbol identifies potential health and safety hazards. It marks safety precautions. Your safety and the safety of others is involved.

There are three signal words that describe the level of safety concern: Danger, Warning, and Caution.

SIGNAL WORD DEFINITIONS

DANGER

Indicates an imminently hazardous situation which, if not avoided, will result in death or serious injury. This signal word is limited to the most extreme cases.

WARNING

Indicates a potentially hazardous situation which, if not avoided, could result in death or serious injury.

CAUTION

Indicates a potentially hazardous situation which, if not avoided, may result in minor or moderate injury and/or property damage. It may also be used to alert against unsafe practices.

This manual also uses two words to highlight information. **ATTENTION** calls attention to special mechanical information to prevent equipment damage and/or best practices for equipment service and care.

NOTE emphasizes general information that is worthy of special attention.

Note: Right-Hand and Left-Hand orientations may be referred to at different places throughout this manual. Right-Hand and Left-Hand is determined as if facing forward from the operator station.

Manual Glossary

- Power Unit** A Ventrac tractor or other Ventrac engine powered device that may be operated by itself or with an attachment or accessory.
- Attachment** A piece of Ventrac equipment that requires a Power Unit for operation.
- Accessory** A device that attaches to a Power Unit or Attachment to extend its capabilities.
- Machine** Describes any "Attachment" or "Accessory" that is used in conjunction with a power unit.

SAFETY



General Safety Procedures for Ventrac Power Units, Attachments, & Accessories



Training Required

- The owner of this machine is solely responsible for properly training the operators.
- The owner/operator is solely responsible for the operation of this machine and for the prevention of accidents or injuries occurring to him/herself, other people, or property.
- Do not allow operation or service by children or untrained personnel. Local regulations may restrict the age of the operator.
- Before operating this machine, read the operator's manual and understand its contents.
- If the operator of the machine cannot understand this manual, then it is the responsibility of this machine's owner to fully explain the material within this manual to the operator.
- Learn and understand the use of all the controls.
- Know how to stop the power unit and the attachments quickly in the event of an emergency.

Requirements for Personal Protective Equipment (PPE)

- The owner is responsible for ensuring that all the operators use the proper PPE while operating the machine. Whenever you use the machine, use the following PPE:
- Certified eye protection and hearing protection.
- Closed toe, slip resistant footwear.
- Long pants or trousers.
- A dust mask for dusty conditions.
- Additional PPE may be required. Refer to the product safety procedures for any additional requirements.

Operation Safety

- Secure long hair and loose clothing. Do not wear jewelry.
- Inspect the machine before operation. Repair or replace any damaged, worn, or missing parts. Be sure the guards and shields are in proper working condition and are secured in place. Make any necessary adjustments before operating the machine.
- Some pictures in this manual may show shields or covers opened or removed in order to clearly illustrate the instructions. Under no circumstance should the machine be operated without these devices in place.
- Alterations or modifications to this machine can reduce safety and could cause damage to the machine. Do not alter the safety devices or operate with the shields or covers removed.
- Before each use, verify that all the controls function properly and inspect all the safety devices. Do not operate if the controls or safety devices are not in proper working condition.
- Check the parking brake function before operating. Repair or adjust the parking brake if necessary.
- Observe and follow all of the safety decals.
- All the controls are to be operated from the operator's station only.
- Always wear a seat belt if the machine has a roll cage/bar installed and in the upright position.

SAFETY



General Safety Procedures for Ventrac Power Units, Attachments, & Accessories



- Ensure the attachment or accessory is locked or fastened securely to the power unit before operating.
- Ensure that all bystanders are clear of the power unit and the attachment before operating. Stop the machine if someone enters your work area.
- Always be alert to what is happening around you, but do not lose focus on the task you are performing. Always look in the direction the machine is moving.
- Look behind and down before backing up to be sure of a clear path.
- If you hit an object, stop and inspect the machine. Make any necessary repairs before operating the machine again.
- Stop operation immediately at any sign of equipment failure. An unusual noise can be a warning of equipment failure or a sign that maintenance is required. Make any necessary repairs before operating the machine again.
- If equipped with a high/low range feature, never shift between high and low range while on a slope. Always move the machine to level ground and engage the parking brake before shifting range.
- Do not leave the machine unattended while it is running.
- Always park the machine on level ground.
- Always shut off the engine when connecting the attachment drive belt to the power unit.
- Never leave the operator's station without lowering the attachment to the ground, engaging the parking brake, shutting off the engine, and removing the ignition key. Make sure all moving parts have come to a complete stop before dismounting.
- Never leave the machine unattended without lowering the attachment to the ground, engaging the parking brake, shutting off the engine, and removing the ignition key.
- Only operate in well-lit conditions.
- Do not operate when there is a risk of lightning.
- Never direct the discharge of any attachment in the direction of people, buildings, animals, vehicles, or other objects of value.
- Never discharge material against a wall or obstruction. The material may ricochet back toward the operator.
- Use extra caution when approaching blind corners, shrubs, trees, or other objects that may obscure your vision.
- Do not run the engine in a building without adequate ventilation.
- Do not touch the engine or the muffler while the engine is running or immediately after stopping the engine. These areas may be hot enough to cause a burn.
- Do not change the engine governor settings or over-speed the engine. Operating the engine at excessive speeds may increase the hazard of personal injury.
- To reduce the hazard of fire, keep the battery compartment, engine, and muffler areas free of grass, leaves, excessive grease, and other flammable materials.
- Clear the working area of objects that might be hit or thrown from the machine.

SAFETY



General Safety Procedures for Ventrac Power Units, Attachments, & Accessories



- Keep people and pets out of the working area.
- Know the work area well before operation. Do not operate where traction or stability is questionable.
- Reduce speed when you are operating over rough ground.
- Equipment can cause serious injury and/or death when improperly used. Before operating, know and understand the operation and safety of the power unit and the attachment being used.
- Do not operate the machine if you are not in good physical and mental health, if you will be distracted by personal devices, or if you are under the influence of any substance which might impair your decisions, dexterity, or judgment.
- Children are attracted to machine activity. Be aware of children and do not allow them in the work area. Turn off the machine if a child enters the work area.
- Power units, attachments, and accessories are not designed or intended for travel on public roadways. Never operate or travel on public roads or highways.
- Operate with safety lights when operating near roadways.
- Slow down and be careful of traffic when operating near or crossing roadways. Stop before crossing roads or sidewalks. Use care when approaching areas or objects that may obscure vision.

Keep Riders Off

- Only allow the operator on the power unit. Keep riders off.
- Never allow riders on any attachment or accessory.

Operating On Slopes

- Slopes can cause loss-of-control and tip-over accidents, which can result in severe injury or death. Be familiar with the emergency parking brake, along with the power unit controls and their functions.
- If the power unit is equipped with a fold down roll bar, it must be locked in the upright position when operating on any slope.
- Use low range (if equipped) when operating on slopes greater than 15 degrees.
- Do not stop or start suddenly when operating on slopes.
- Never shift between high and low range while on a slope. Always move the power unit to level ground and engage the parking brake before shifting range or placing the power unit in neutral.
- Variables such as wet surfaces and loose ground will reduce the degree of safety. Do not drive where the machine could lose traction or tip over.
- Keep alert for hidden hazards in the terrain.
- Stay away from drop-offs, ditches, and embankments.
- Sharp turns should be avoided when operating on slopes.
- Pulling loads on hills decreases safety. It is the responsibility of the owner/operator to determine loads that can safely be controlled on slopes.

SAFETY



General Safety Procedures for Ventrac Power Units, Attachments, & Accessories



- Transport the machine with the attachment lowered or close to the ground to improve stability.
- While operating on slopes, drive in an up and down direction whenever possible. If turning is necessary while driving across slopes, reduce your speed and turn slowly in the downhill direction.
- Ensure a sufficient supply of fuel for continuous operation. A minimum of one-half tank of fuel is recommended.

Truck Or Trailer Transport

- Use care when loading or unloading the machine into a truck or trailer.
- Use full width ramps for loading the machine into a truck or trailer.
- The parking brake is not sufficient to lock the machine during transport. Always secure the power unit and/or attachment to the transporting vehicle securely using straps, chains, cables, or ropes. Both the front and rear straps should be directed down and outward from the machine.
- Shut off the fuel supply to the power unit during transport on a truck or trailer.
- If equipped, turn the battery disconnect switch to the Off position to shut off electrical power.

Maintenance

- Keep the safety decals legible. Remove all grease, dirt, and debris from the safety decals and instructional labels.
- If any decals are faded, illegible, or missing, contact your dealer promptly for replacements.
- When new components are installed, be sure that the current safety decals are affixed to the replacement components.
- If any component requires replacement, use only original Ventrac replacement parts.
- Always turn the battery disconnect to the Off position or disconnect the battery before performing any repairs. Disconnect the negative terminal first and the positive terminal last. Reconnect the positive terminal first and the negative terminal last.
- Keep all bolts, nuts, screws, and other fasteners properly tightened.
- Always lower the attachment to the ground, engage the parking brake, shut off the engine, and remove the ignition key. Make sure all moving parts have come to a complete stop before cleaning, inspecting, adjusting, or repairing.
- If the power unit, attachment, or accessory requires repairs or adjustments not instructed in the operator's manual, the power unit, attachment, or accessory must be taken to an authorized Ventrac dealer for service.
- Never perform maintenance on the power unit and/or attachment if someone is in the operator's station.
- Always use protective glasses when handling the battery.
- Check the fuel lines for tightness and wear on a regular basis. Tighten or repair them as needed.
- To reduce the hazard of fire, keep the battery compartment, engine, and muffler areas free of grass, leaves, and excess grease.
- Do not touch the engine, the muffler, or other exhaust components while the engine is running or immediately after stopping the engine. These areas may be hot enough to cause a burn.

SAFETY



General Safety Procedures for Ventrac Power Units, Attachments, & Accessories



- Allow the engine to cool before storing and do not store near an open flame.
- Do not change the engine governor settings or over-speed the engine. Operating engine at excessive speeds may increase the hazard of personal injury.
- Springs may contain stored energy. Use caution when disengaging or removing springs and/or spring loaded components.
- An obstruction or blockage in a drive system or moving/rotating parts may cause a buildup of stored energy. When the obstruction or blockage is removed, the drive system or moving/rotating parts may move suddenly. Do not attempt to remove an obstruction or blockage with your hands. Keep your hands, feet, and clothing away from all power-driven parts.

Fuel Safety

- To avoid personal injury or property damage, use extreme care in handling gasoline. Gasoline is extremely flammable and the vapors are explosive.
- Do not refuel the machine while smoking or at a location near flames or sparks.
- Always refuel the machine outdoors.
- Do not store the machine or fuel container indoors where the fumes or fuel can reach an open flame, spark, or pilot light.
- Only store fuel in an approved container. Keep out of the reach of children.
- Never fill containers inside a vehicle or on a truck or trailer bed with a plastic liner. Always place the containers on the ground away from your vehicle before filling.
- Remove the machine from the truck or trailer and refuel it on the ground. If this is not possible, refuel the machine using a portable container, rather than from a fuel dispenser nozzle.
- Never remove the fuel cap or add fuel with the engine running. Allow the engine to cool before refueling.
- Never remove the fuel cap while on a slope. Only remove the fuel cap when parked on a level surface.
- Replace the fuel tank cap and the container cap securely.
- Do not overfill the fuel tank. Only fill to the bottom of the fuel neck, do not fill the fuel neck full. Overfilling of the fuel tank could result in engine flooding, fuel leakage from the tank, and/or damage to the emissions control system.
- If fuel is spilled, do not attempt to start the engine. Move the power unit away from the fuel spill and avoid creating any source of ignition until the fuel vapors have dissipated.
- If the fuel tank must be drained, it should be drained outdoors into an approved container.
- Check the fuel lines for tightness and wear on a regular basis. Tighten or repair them as needed.
- The fuel system is equipped with a shut-off valve. Shut off the fuel when transporting the machine to and from the job, when parking the machine indoors, or when servicing the fuel system.

SAFETY



General Safety Procedures for Ventrac Power Units, Attachments, & Accessories



Hydraulic Safety

- Make sure the hydraulic connections are tight and all hydraulic hoses and tubes are in good condition. Repair any leaks and replace any damaged or deteriorated hoses or tubes before starting the machine.
- Hydraulic leaks can occur under high pressure. Hydraulic leaks require special care and attention.
- Use a piece of cardboard and a magnifying glass to locate suspected hydraulic leaks.
- Keep your body and hands away from pinhole leaks or nozzles that eject high pressure hydraulic fluid. Hydraulic fluid escaping under high pressure can penetrate the skin causing serious injury, leading to severe complications and/or secondary infections if left untreated. If hydraulic fluid is injected into the skin, seek immediate medical attention no matter how minor the injury appears.
- The hydraulic system may contain stored energy. Before performing maintenance or repairs on the hydraulic system, remove any attachments, engage the parking brake, disengage the weight transfer system (if equipped), shut off the engine, and remove the ignition key. To relieve pressure on the auxiliary hydraulic system, shut off the power unit engine and move the hydraulic control lever left and right before disconnecting the auxiliary hydraulic quick couplers.

SAFETY



4520 Safety Procedures



- The weight transfer spring may contain stored energy. Always disengage the weight transfer system (if equipped) before performing maintenance or repairs on the weight transfer system, the front hitch, or the lift hydraulics.

Roll Over Protective Structure (ROPS)

WARNING

Keep the ROPS locked in the upright position and the seat belt securely fastened during operation. Failure to do so could result in serious injury or loss of life.

WARNING

Alterations or modifications to this machine and/or the ROPS structure can reduce safety and could cause damage to the machine. Do not alter the ROPS. Do not alter any other safety devices.

Your power unit is equipped with a Roll Over Protective Structure (ROPS). This ROPS was tested and certified in accordance with the following standards.

ROPS: SAE J1194 and OSHA 1928.51 = maximum GVW of 1,818 kg (4,000 pounds).

ISO 21299 = maximum GVW of 1,329 kg (2,930 pounds).

Seat Belt Anchorage: ISO 3776-2, ISO 3776-3, ISO 6683, & SAE J386

- The ROPS certification applies only when the roll bar is locked in the upright position. Be aware that there is no rollover protection when a folding ROPS is in the down position.
- DO NOT remove the ROPS. Alterations to the ROPS structure are not permitted.
- Lower the roll bar only when absolutely necessary and raise the roll bar to the upright position as soon as clearance allows. Never lower a folding ROPS in areas where there are slopes, drop offs, or water.
- Check carefully for overhead clearances (i.e. branches, doorways, electrical wires) before driving under any objects and do not contact them.
- Always wear the seat belt when the roll bar is locked in the upright position. Be certain the seat belt can be released quickly in the event of an emergency.
- Do not wear a seat belt when the roll bar has been lowered to the down position.
- If any part of this ROPS experiences structural damage, the entire ROPS must be replaced.
- Inspect the seat belt for wear or damage before use. Failure to inspect or maintain the seat belt can cause injury or loss of life.

Operator Access System

- The operator access system is on the left side of the power unit. Mount and dismount the 4520 power unit only from the left side.

SAFETY

California Proposition 65



Warning

Operating, servicing, and maintaining off-road equipment can expose you to chemicals including engine exhaust, carbon monoxide, phthalates, and lead, which are known to the State of California to cause cancer and birth defects or other reproductive harm. To minimize exposure, avoid breathing exhaust, do not idle the engine except as necessary, service equipment in a well-ventilated area and wear gloves or wash your hands frequently when servicing your equipment.

For more information go to www.P65Warnings.ca.gov

Attention

It is a violation of California Public Resource Code Section 4442 or 4443 to use or operate this engine on any forest-covered, brush-covered, or grass-covered land unless the exhaust system is equipped with a spark arrestor, as defined in Section 4442 maintained in effective working order or the engine is constructed, equipped, and maintained for the prevention of fire.

Operator Safety Interlock System

The 4520 power unit is equipped with a safety interlock system. This system:

- Prevents the engine from starting unless the parking brake is engaged and the SDLA control is in neutral.
- Prevents the PTO from starting if the operator is not in the seat.
- Prevents the power unit from driving if the parking brake is engaged.*
- Shuts off the PTO if the operator leaves the seat.
- Shuts off the engine (and fuel pump) if the operator leaves the seat without engaging the parking brake.
- Shuts off the engine if the forward / reverse controls (SDLA lever or foot pedal) are moved from neutral while the parking brake is engaged.

* The parking brake must be completely disengaged before moving the SDLA lever forward or backward or the power unit engine will shut off.

Testing the Safety Interlock System

WARNING

Never operate the power unit if the safety interlock system is malfunctioning. Do not disengage or bypass any switch. Failure to heed this warning could result in injury to yourself or others, or damage to property.

WARNING

The parking brake must be disengaged during portions of the safety interlock system test. Place wheel chocks in front and back of the wheels to prevent the power unit from moving.

CAUTION

The daily inspection should be performed prior to initial startup for the day.

Perform the following safety interlock tests daily to test the electrical portion of the interlock system. Before testing, park the power unit on a level surface, place wheel chocks in front and back of the wheels, and place the high/low range shift lever in the neutral position. After testing is complete, place the high/low shift lever in either high or low range, engage the parking brake, and remove the wheel chocks.

SAFETY

Testing the Safety Interlock System (continued)

Tests 1-4 test the 'Engine Start' function. For each test, turn the ignition key to the RUN position (do not start the engine). As listed for each test, engage or disengage the parking brake*, place the SDLA in neutral or out of neutral^, and sit on the seat or raise your body weight from the seat. The engine starter should or should not engage as described for each test.

	Test Number	Parking Brake* Engaged	Forward/Reverse Control (SDLA) in Neutral^	Operator Present in Seat	Engine Starts
Engine Start	1	No	Yes	Yes	No
	2	Yes	No	Yes	No
	3	Yes	Yes	No	Yes
	4	Yes	Yes	Yes	Yes

Tests 5-9 test the 'Engine Run' function. For each test, start the power unit so that the engine is running. As listed for each test, engage or disengage the parking brake*, place the SDLA in neutral or out of neutral^, and sit on the seat or raise your body weight from the seat. The engine should continue running or stop running as described for each test.

	Test Number	Parking Brake* Engaged	Forward/Reverse Control (SDLA) in Neutral^	Operator Present in Seat	Engine Runs
Engine Run	5	Yes	Yes	Yes	Yes
	6	Yes	Yes	No	Yes
	7	Yes	No	No	No
	8	Yes	No	Yes	No
	9	No	Yes	No	No

Tests 10-13 test the 'PTO' function. For each test, turn the ignition key to the RUN position (do not start the engine). As listed for each test, place the PTO switch in the On or OFF position and sit on the seat or raise your body weight from the seat. The electric PTO clutch will make an audible noise when it engages or disengages.

	Test Number	PTO Switch	Operator Present in Seat	PTO Clutch
PTO	10	Off	Yes	Off
	11	Pull to 'On' Position	No	No
	12	Pull to 'On' Position	Yes	Yes
	13	On	Raise Operator Body Weight from Seat	PTO Disengages (1/2 second delay)

If the power unit fails any one of the safety interlock tests, the issue must be corrected before operating the power unit.

*This tests the function of the parking brake switch. The parking brake handle should be engaged the minimum amount necessary to activate the parking brake indicator light on the information gauge. Neutral assist must be off.

^This tests the function of the neutral switch located on the hydraulic pump. Depending on settings and the age of the power unit, the range for neutral for the SDLA control may vary. For this test, the SDLA lever should move 2.5 cm (1 inch) or less forward or backward for neutral switch activation (measured at the top of the lever).

SAFETY

Safety Decals

The following safety decals must be maintained on your power unit.

Keep all safety decals legible. Remove all grease, dirt, and debris from safety decals and instructional labels. If any decals are faded, illegible, or missing, contact your dealer promptly for replacements.

When new components are installed, be sure that current safety decals are affixed to the replacement components.



SAFETY



1. Warning - Read operator's manual.
2. Rollover hazard - Roll bar must be in the raised and locked position when operating on slopes.
3. Always wear a seat belt when operating with the roll bar in the upright position. Do not wear a seat belt when operating with the roll bar in the lowered position.



1. Warning - Explosion/fire hazard.
2. Keep away from fire, sparks, and pilot lights when refueling or storing machine and fuel.
3. Smoking is prohibited.
4. Use unleaded gasoline only with an ethanol content of 10 percent or less.

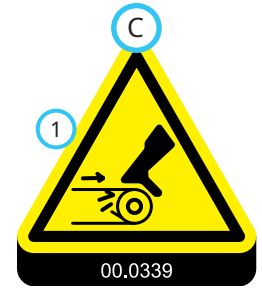

1. Cutting/entanglement hazard - Stay away from moving parts.



1. Read the operator's manual.
2. Operators must receive training prior to operating the machine.
3. Wear personal protective gear, such as safety glasses, closed toe shoes or boots, and ear protection.
4. Stay away from moving parts.
5. Keep all guards and shields in place.
6. WARNING: Hydraulic fluid is under high pressure and can penetrate skin, causing injury. Keep hands, face, and body away from pinholes or nozzles that eject hydraulic fluid under high pressure.
7. Do not operate while under the influence of drugs or alcohol.
8. Do not carry passengers. Stop the machine if someone enters the area.
9. WARNING: Stay away from the edge of drop-offs, ditches, and embankments. The machine could roll over if a wheel drops over the edge or if the edge caves in.
10. WARNING: Read slope operation instructions. Use low range when operating on slopes. Keep the roll bar in the raised and locked position and the seat belt securely fastened.
11. When towing or pushing the power unit, the transaxles must be disengaged by moving the high/low range shift handle to the neutral position or damage to the hydraulic system will result.

SAFETY



1. Pinching or crushing hazard - foot. Stay away from moving parts.



1. Caustic liquid/chemical burns hazard.
2. Explosion hazard - batteries produce flammable and explosive gases.
3. Do not expose the battery to arcs, sparks, or open flame. Do not smoke near batteries.
4. Keep bystanders away from the battery.
5. Wear eye protection, such as goggles or a face shield, when checking or servicing batteries.
6. Wear protective gear, such as rubber gloves and an apron, when checking or servicing batteries.

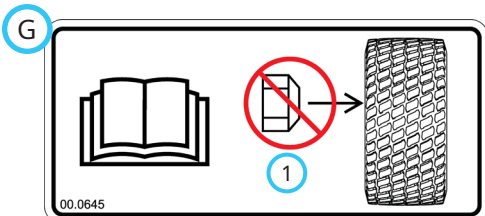

1. Place this side of the rim against the axle hub. Do not install the wheel lug nuts on this side of the rim. Refer to the operator's manual.

00.0642

	A	B	C
9	55-110 kPa (8-16 psi)	55-69 kPa (8-10 psi)	41-55 kPa (6-8 psi)
10	55-110 kPa (8-16 psi)	55-69 kPa (8-10 psi)	41-55 kPa (6-8 psi)
11	103-138 kPa (15-20 psi)	103-117 kPa (15-17 psi)	69-83 kPa (10-12 psi)

1. Warning - 20 degree maximum slope rating when equipped with single wheels.
2. Warning - 25 degree maximum slope rating when equipped with 7.6 cm (3 inch) wheel extensions.
3. Warning - 30 degree maximum slope rating when equipped with dual wheels.
4. Slope rating may be reduced when adding a cab and other accessories or attachments. Read the operator's manual for the cab, accessory, or attachment being used.
5. Reduce speed on slopes, especially when turning. Avoid sharp turns when operating on slopes.
6. Use low range when operating on slopes. Do not shift between high and low range on a slope.
7. Torque the wheel lug nuts to 75 Nm (55 ft-lbs).
8. Torque the dual wheel hub draw bolts to 163 Nm (120 ft-lbs).
9. Inflate All Terrain tires to the pressure range indicated for single wheels and the inner and outer dual wheels.
10. Inflate Bar tires to the pressure range indicated for single wheels and the inner and outer dual wheels.
11. Inflate Turf tires to the pressure range indicated for single wheels and the inner and outer dual wheels.

SAFETY



1. Severing of fingers or hand - engine fan. Stay away from moving parts.



1. Cutting or pinching hazard. Stay away from moving parts.

Decal	Description	Part Number	Quantity
A	ROPS 4500/4520	00.0644	1
B	Gasoline Safety	00.0457	1
C	Moving Parts	00.0339	1
D	4520 Safety	00.0694	1
E	Pinching Hazard Foot	00.0639	2
F	Battery Hazard	00.0629	1
G	Hub Side	00.0645	4
H	Slope Warning	00.0642	1
I	Fan Blade Hazard	00.0638	1
J	Pinch Point Hazard (optional kit)	00.0364	2

OPERATIONAL CONTROLS

Standard Control Locations

Become familiar with all the controls before you start the engine and operate the machine.

- A. Information Cluster Gauge
- B. Warning Alarm (Continuous)
- C. Ignition Switch
- D. Throttle Lever
- E. High/Low Shift Lever
- F. Steering Wheel
- G. Parking Brake
- H. Front Hitch Latch Lever
- I. Front Hitch Latch Lever Lock
- J. Neutral Assist Lever
- K. Auxiliary Hydraulic Quick Couplers
- L. PTO Belt Tensioner Rod

- M. Primary SDLA Control Lever
- N. Secondary SDLA Control Lever
- O. PTO Switch
- P. Headlight Switch
- Q. USB Receptacle
- R. Seat Slide Lever
- S. Fuel Shut-off Valve
- T. Circuit Breaker and Battery Disconnect
- U. Seat Prop Plate
- V. Seat Latch Strap
- W. Weight Transfer Select Lever

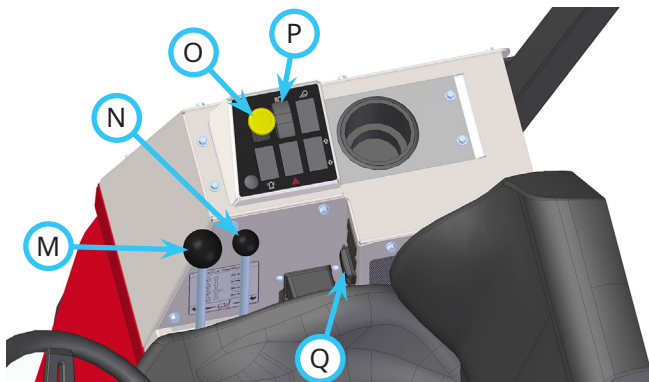
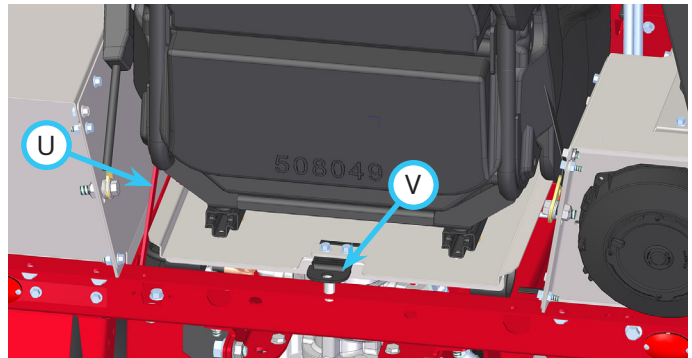
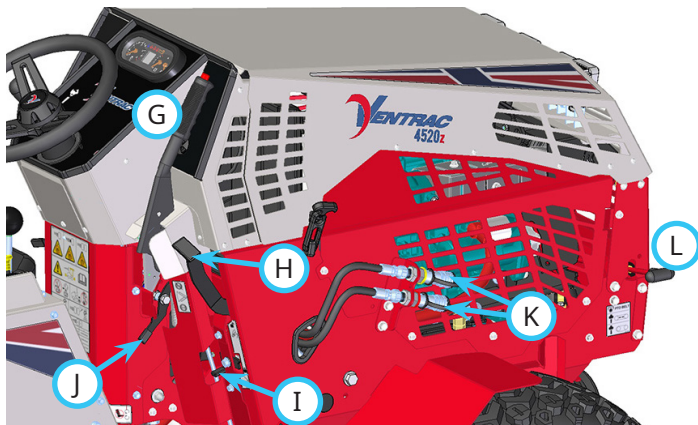
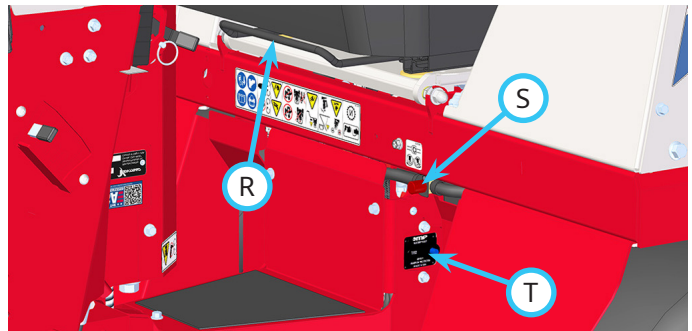
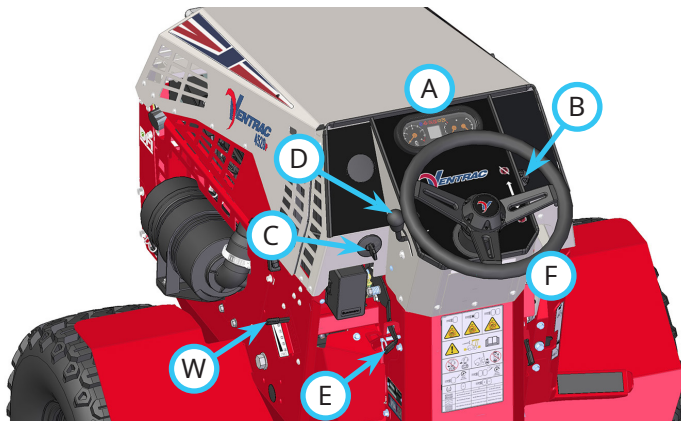

OPERATIONAL CONTROLS

Optional Accessory Control Locations

Become familiar with all the controls before you start the engine and operate the machine.

- AA. Work Light Switch
- BB. Strobe Light Switch
- CC. Directional Signal Switch
- DD. Hazard Flasher Switch
- EE. Horn Switch
- FF. Front 12V Switch (On/Off)
- GG. Front 12V Switch (Momentary On/Off/On)
- HH. Front 12V 4-Pin Socket
- II. Dual Front Hydraulic Auxiliary Switch
- JJ. Dual Front Hydraulic Auxiliary Valve
- KK. Rear 12V Switch (On/Off)
- LL. Rear 12V Switch (Momentary On/Off/On)
- MM. Rear 12V 4-Pin Socket

- NN. Slope Indicator Gauge
- OO. Foot Pedal
- PP. 3 Point Hitch Control Lever
- QQ. Left Rear Auxiliary Hydraulics Handle
- RR. Right Rear Auxiliary Hydraulics Handle
- SS. Rear Auxiliary Hydraulic Quick Couplers
- TT. Back-Up Alarm
- UU. Seat Slide Lever
- VV. Lumbar Support Knob
- WW. Backrest Angle Lever
- XX. Weight Adjustment Lever
- YY. Heat Switch
- ZZ. Optional Armrest Angle Knob
- BA. Front Hitch Valve

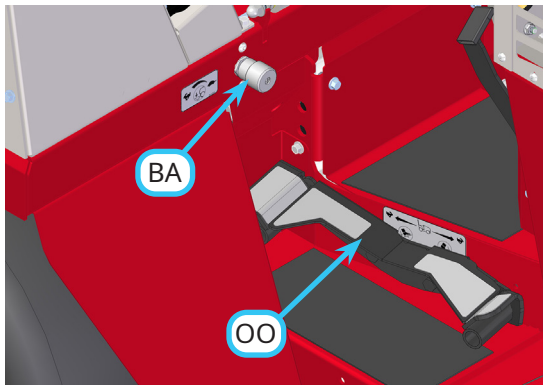
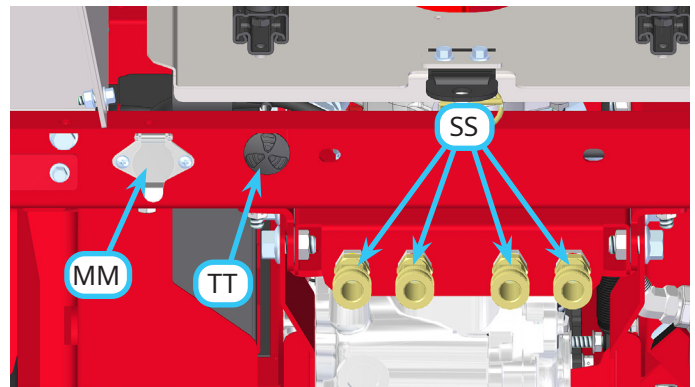
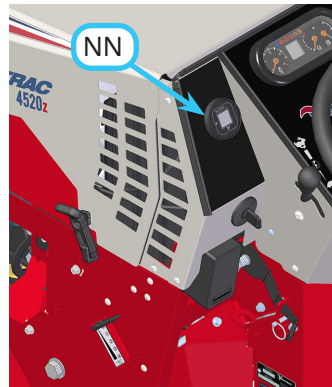
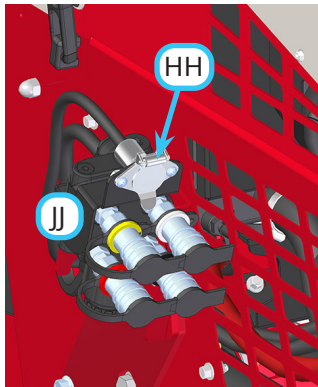
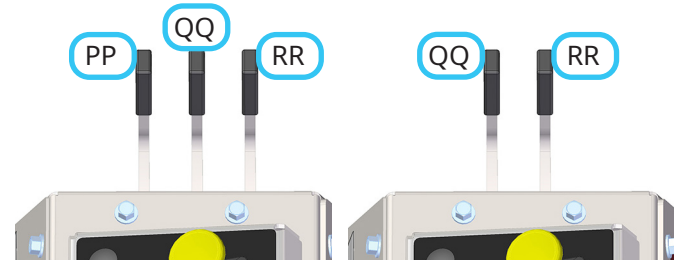
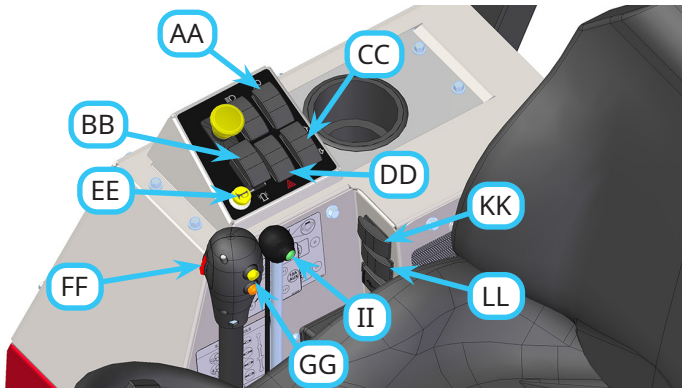

OPERATIONAL CONTROLS

Information Cluster Gauge (A)

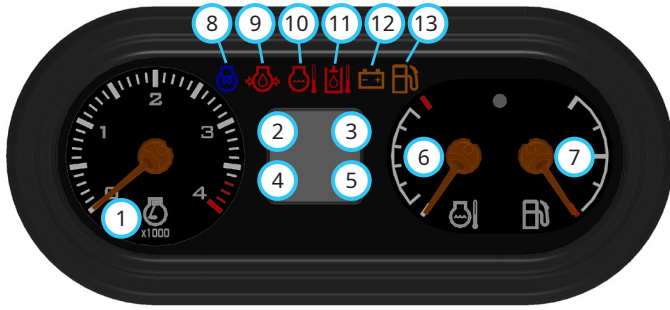

- | | |
|----------------------------|------------------------------------|
| 1. Tachometer | 8. Glow Plug Indicator |
| 2. Speedometer | 9. Low Engine Oil Pressure |
| 3. Parking Brake Indicator | 10. High Water Temperature |
| 4. Hour Meter | 11. High Hydraulic Oil Temperature |
| 5. Volt Meter | 12. Low Voltage |
| 6. Water Temperature Gauge | 13. Low Fuel |
| 7. Fuel Gauge | |

The information cluster gauge contains a tachometer, speedometer, hour meter, volt meter, water temperature gauge, fuel gauge, and a parking brake indicator. It also contains an indicator light for the glow plugs and warning lights for low engine oil pressure, high water temperature, high hydraulic oil temperature, low voltage, and low fuel.

The information cluster gauge is equipped with a light sensor that turns the gauge light on or off based on ambient light conditions. Depending on the difference in the light and dark conditions, the gauge light response time may be delayed.

The **tachometer** displays the engine speed in RPM.

The **speedometer** displays the speed of the power unit when the power unit is in motion. The speedometer can be set to display speed in either miles per hour (mph) or kilometers per hour (km/h). When the power unit is stopped, this window displays the parking brake indicator.

The **parking brake indicator** shows whether the parking brake is engaged or disengaged. This indicator is only displayed when the power unit is stopped. When the power unit is in motion, this window displays the power unit's speed.

The **hour meter** records the accumulated time the ignition key has been switched to the On position. The hour meter is displayed when the power unit engine is not running and the key is switched to the On position.

The **volt meter** displays the voltage level of the charging system. The voltage is displayed when the power unit engine is running.

The **water temperature gauge** displays the temperature of the engine cooling system.

The **fuel gauge** displays the level of fuel in the tank.

The **glow plug indicator** is only used with diesel engines. It is not applicable to this engine.

The **low engine oil pressure light** activates and an alarm sounds when the engine oil pressure is below safe levels. The light comes on when the ignition key is switched to the On position and stays illuminated until the engine is started and safe oil pressure develops. If this light comes on during operation, shut off the engine immediately. Do not restart the engine until the problem has been located and corrected.

The **high water temperature light** activates and an alarm sounds when the temperature of the engine cooling system reaches unsafe levels. If this light comes on during operation, park the power unit, turn off the PTO, move the throttle lever to the low idle position, and allow the engine to cool. Check the radiator screen and clean if needed. If the engine temperature continues to rise, shut off the engine. If the engine continually overheats, refer to the troubleshooting chapter for possible problems.

The **high hydraulic oil temperature light** activates and an alarm sounds when the hydraulic oil temperature reaches unsafe levels. If this light comes on during operation, park the power unit and move the throttle lever to the slow idle position. Check the hydraulic cooling fan to ensure it is operating properly and refer to the troubleshooting chapter for possible problems.

The **low voltage light** activates and an alarm sounds when the voltage drops below acceptable levels. If this light comes on, shut off any unnecessary lights and accessories to reduce the current draw. If the voltage continues to drop, park the power unit, shut off the engine, and turn the ignition key to the Off position. Refer to the troubleshooting chapter for possible problems.

The **low fuel light** activates to alert the operator when the fuel level is low. When this light comes on, the fuel tank should be refilled.

OPERATIONAL CONTROLS

Warning Alarm (B)

The warning alarm works with the information cluster gauge to alert the operator to problems. When a condition activates a warning light on the gauge, the warning alarm also activates and sounds a continuous signal alarm to alert the operator. If the warning alarm sounds, check the lights on the information gauge to determine the cause of the warning alarm and then take appropriate action.

Ignition Switch (C)

1. Off or Stop Position - all 12 volt power going through the ignition switch is off.
2. On or Run Position - engine run position, 12 volt power is sent to accessories.
3. Start Position - when the key is turned to the start position, the starter will engage.

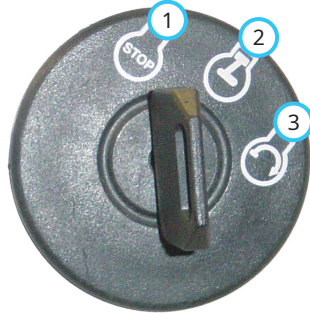

Throttle Lever (D)

Moving the throttle lever forward toward the fast position (1) increases the engine Revolutions Per Minute (RPM). Moving the throttle lever backward toward the slow position (2) decreases the engine RPM.



High/Low Shift Lever (E)

ATTENTION

The high/low range shift lever shifts both the front and rear transaxles simultaneously. Occasionally, the engagement of the transaxle gears is prevented by misalignment. Moving the steering wheel slightly to the right or left will move the gears enough to complete the engagement.

CAUTION

Never shift while under load, while moving, or while on a slope. Always ensure the shift lever is secured in the lock position at the end of each shift stroke. Always install the ball pin to prevent the shift lever from accidentally moving to the neutral position.

With the power unit parked on level ground, remove the ball pin (A) and push the shift lever forward to select low range (1).

Move the shift lever to the middle of the shift stroke to place the transaxle gears in neutral (0).

Pull the shift lever back toward the operator to select high range (2).

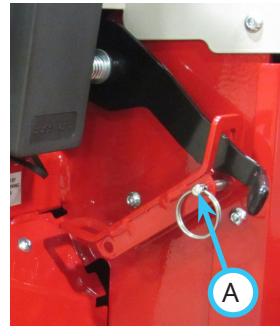

Ensure the shift lever is secured in the lock position at the end of the shift stroke. Reinstall the ball pin (A) into the shift select bracket position at the same end as the shift lever, in order to prevent the shift lever from being accidentally disengaged.

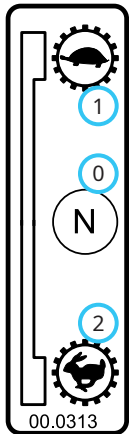

OPERATIONAL CONTROLS

Steering Wheel (F)

Turn the steering wheel to the left (counterclockwise) to turn the power unit to the left. Turn the steering wheel to the right (clockwise) to turn the power unit to the right.

Parking Brake (G)

When parking the power unit, always engage the parking brake to prevent accidental movement of the machine.

To engage the parking brake, pull the brake handle back toward the operator.

To disengage the parking brake, pull back slightly on the brake handle to relieve pressure, push down the release button (3) on the top of the handle, and push the handle forward. If the parking brake is engaged, any attempt to move the power unit will shut off the engine. If the operator leaves the seat without engaging the parking brake, the engine will shut off.

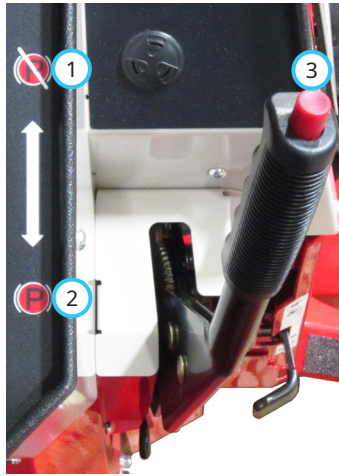

1. Parking Brake Disengaged
2. Parking Brake Engaged
3. Parking Brake Release Button

Front Hitch Latch Lever (H)

The front hitch latch lever locks and unlocks the hitch latch.

Raise the front hitch latch lever to the unlock position (1) to unlock the hitch latch when attaching or detaching a front mounted attachment.

Lower the front hitch latch lever to the lock position (2) to lock the hitch latch over the hitch arm pins on the attachment. Ensure the lever is secured in the frame notch and the front hitch latch lever lock is in place.

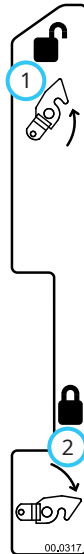

Front Hitch Latch Lever Lock (I)

The front hitch latch lever lock prevents the accidental release of the front hitch latch lever. To release the front hitch latch lever, lift the tab on the front hitch latch lever lock, then move the front hitch latch lever to the unlock position.

Neutral Assist Lever (J)

Placing the neutral assist lever in the On position (2) engages the neutral assist spring to help return the SDLA control lever to the neutral position. This makes the neutral position easy to select and maintain. The neutral assist On position is recommended when learning the operation of the power unit, loading or unloading the power unit, attaching and removing attachments, and whenever the operator is unsure of the power unit's response to the task being performed.

Placing the neutral assist lever in the Off position (1) disengages the neutral assist spring. This position is designed for experienced operators when using the power unit in open areas where travel speed and direction are relatively constant and control is easily maintained. The neutral assist Off position reduces operator arm fatigue when using the power unit for prolonged periods of time.

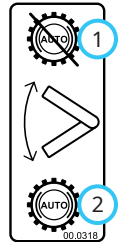

CAUTION

Stopping the power unit with the neutral assist lever in the Off position requires the operator to manually return the SDLA control lever or foot pedal to the neutral position.

Auxiliary Hydraulic Quick Couplers (K)

The two couplers are a part of the auxiliary hydraulic circuit and are used with an attachment which requires hydraulics (e.g. to angle a dozer blade or rotate the discharge on a snow blower).

OPERATIONAL CONTROLS

PTO Belt Tensioner Rod (L)

The PTO belt tensioner rod applies or releases belt tension to the attachment drive belt.

After placing the attachment drive belt onto the PTO drive pulley, push the PTO belt tensioner rod in (1) until it locks in position with tension applied to the attachment drive belt.

Pulling the PTO belt tensioner rod out (2) releases the belt tension, allowing the operator to remove or install the attachment drive belt.

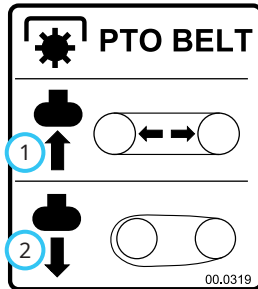

SDLA Control Lever (M & N)

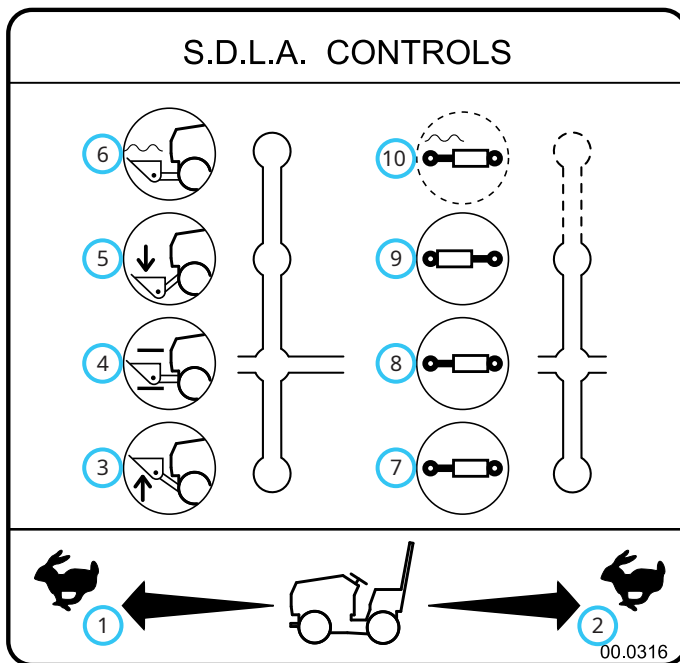

- | | |
|----------------------|-------------------------|
| 1. Forward Direction | 6. Float |
| 2. Reverse Direction | 7. Direction #1 |
| 3. Lift | 8. Hold |
| 4. Hold | 9. Direction #2 |
| 5. Lower | 10. Float (if equipped) |

The SDLA (Speed, Direction, Lift, & Auxiliary) is the primary control for the power unit and consists of two levers. The primary SDLA control lever (M) controls the speed, the direction of travel, and the lift of the hitch arms. The secondary SDLA control lever (N) controls the auxiliary hydraulic circuit.

S - Speed: the amount of forward or backward movement of the primary SDLA lever controls the ground speed of the power unit.

D - Direction: the forward or backward movement of the primary SDLA lever controls the direction of the power unit.

L - Lift: the lift function of the primary SDLA lever has four positions: Up, Hold, Down, and Float Lock. Hold is the default position and holds the hitch arms from moving up or down. Pulling the lever to the left raises the hitch arms. Pushing the lever to the right lowers the hitch arms. Float position is attained by pushing the lever to the right until the float detent engages and locks the lever in place.

A - Auxiliary: the left or right movement of the secondary SDLA lever controls the functions of the attachments that require the auxiliary hydraulic circuit. An optional float kit (part # 23.0210) is available for the auxiliary hydraulic circuit.

Power Take Off (PTO) Switch (O)

Pull the PTO switch up to the On position (2) to engage the electric clutch and send power to the front attachment.

Push the PTO switch down to the Off position (1) to disengage the clutch and stop the attachment. NOTE: the PTO will shut off automatically if the operator leaves the seat. To restart the PTO, cycle the PTO switch to the Off position, then back to the On position.



Headlight Switch (P)

Press the top (1) of the headlight switch to turn on the headlights and taillights. Press the bottom (2) of the switch to turn the lights off.

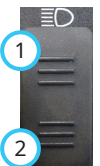

USB Receptacle (Q)

The USB receptacle has two USB charging ports with a sealed cover.

Seat Slide Lever (R)

Lift seat slide lever up to release the seat lock. Move the seat forward or backward to the desired position and release the seat slide lever to lock the seat in place.

OPERATIONAL CONTROLS

Fuel Shut-off Valve (S)

The fuel shut-off valve controls the flow of fuel to the power unit engine. Turn the valve counterclockwise (1) to the stop to allow fuel to flow to the engine.

Turn the valve clockwise (0) to the stop to shut off fuel flow to prevent fuel leakage when changing the fuel filters or when servicing the fuel system.

Turn off the fuel shut-off valve when transporting the power unit on a truck or trailer and when parking the power unit indoors.

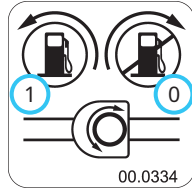

Circuit Breaker & Battery Disconnect (T)

The circuit breaker/battery disconnect switch controls power to the entire electrical system.

Pushing the button (0) on the switch disables the electrical system, allowing electrical components to be serviced.

When the button on the switch is pushed to disengage electrical power, a reset lever (1) drops down from the switch body. Lift up on the reset lever to restore electrical power.



- 0. Push to disengage power
- 1. Lift to restore power

Seat Prop Plate (U)

The seat prop plate secures the seat in the flipped forward position while service is performed under the seat.

To secure, tilt the seat forward, lift up the seat prop plate, and insert the end into the wide portion of the seat plate slot. Ensure the seat prop plate snaps into the narrow portion of the slot to prevent accidental release.

To release, move the seat prop plate over into the wide portion of the seat slot and tilt the seat forward. Lower the seat prop plate back into the seat box and lower the seat back down to the operating position.

Seat Strap Latch (V)

The seat latch strap secures the seat during transport of the power unit.

To secure the seat, place the tab of the seat latch strap over the seat latch pin. Install the linch pin through the hole in the seat latch pin to secure.

To release the seat so that it can be tilted forward for service, remove the linch pin and lift the tab of the seat latch strap off the seat latch pin.

Weight Transfer Traction Control Select Lever (W)

The weight transfer system transfers weight from the attachment to the front wheels of the power unit. Transferring weight from the attachment to the power unit increases the traction control, improves hillside maneuverability, aids in lifting the attachment, reduces the steering effort, and lessens the attachment resistance when in contact with the ground.

The operator can select different transfer rates by selecting one of the five positions from no weight transfer (0) to maximum weight transfer (4). Set the weight transfer to 0 when attaching or detaching any attachment.

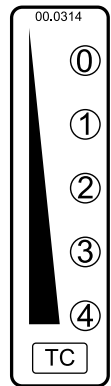

OPERATIONAL CONTROLS

Work Light Switch (AA)

Press the top (1) of the work light switch to turn on the work lights. Press the bottom (2) of the switch to turn the work lights off.



Strobe Light Switch (BB)

Press the top (1) of the strobe light switch to turn on the strobe light. Press the bottom (2) of the switch to turn the strobe light off.



Directional Signal Switch (CC)

Press the left side (1) of the directional signal switch to turn on the left turn signal. Press the right side (2) of the directional signal switch to turn on the right turn signal. Return the switch to the middle position to turn off the signals. The left and right turn signals will override the hazard flashers.



Hazard Flasher Switch (DD)

Pressing the top (1) of the hazard flasher switch flashes both of the directional turn signal lights. Press the bottom (2) of the switch to turn the hazard flasher lights off. Use of the directional turn signals will override the hazard flashers until the turn signal is turned off.



Horn Switch (EE)

Press the horn switch to sound the signal horn. The horn will sound until the horn switch is released.

12 Volt Front Switches and 4-Pin Socket (FF, GG, and HH)

ATTENTION

The 4-pin socket is designed for use with Ventrac original equipment only.

This connector is rated for 20 amp maximum current draw. The engine alternator and/or battery capacity determine allowable continuous draw.

The front 4-pin socket provides electrical power to attachments that are equipped with electrical controls (e.g. broom rotation actuator, snow blower discharge chute angle). The switches turn off and on the electrical power to the front 4-pin socket.

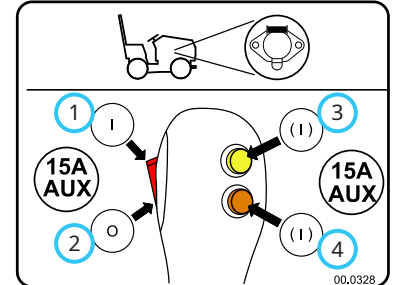

Press the top (1) of the rocker switch to turn on the electrical power to the 4-pin socket. Press the bottom (2) of the rocker switch to turn off the electrical power.

Press and hold either the top (3) or bottom (4) momentary switch to turn on the electrical power to the 4-pin socket. Release the switch to turn off the electrical power.

Dual Front Hydraulic Auxiliary Switch (II)

The optional switch handle is part of the dual front hydraulic auxiliary kit and is used to select which set of quick couplers is controlled by the secondary SDLA lever. The secondary SDLA lever operates the quick couplers with the red and yellow indicators until the button on the handle is pressed. Press and hold the button to switch the secondary SDLA lever to operate the quick couplers with the white and black indicators. Release the button to return to normal operation.

Dual Front Hydraulic Auxiliary Valve (JJ)

The dual front hydraulic auxiliary valve is used with attachments that are equipped with four hydraulic hoses. The valve uses a switch on the secondary SDLA lever to operate the desired set of quick couplers.

OPERATIONAL CONTROLS

12 Volt Rear Switches and 4-Pin Socket (KK, LL, and MM)

ATTENTION

The 4-pin socket is designed for use with Ventrac original equipment only.

This connector is rated for 20 amp maximum current draw. The engine alternator and/or battery capacity determine allowable continuous draw.

The rear 4-pin socket provides electrical power to rear mounted attachments that are equipped with electrical controls. (e.g. ES220 spreader). The switches turn off and on the electrical power to the rear 4-pin socket.

Press the right side (1) of the upper switch to turn on the electrical power to the 4-pin socket. Press the left side (2) of the switch to turn off the electrical power.

Press and hold either the right (3) or left (4) side of the lower momentary switch to turn on the electrical power to the 4-pin socket. Release the switch to turn off the electrical power.

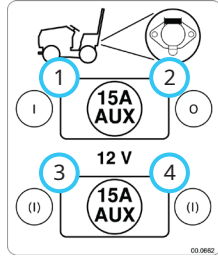

Foot Pedal (OO)

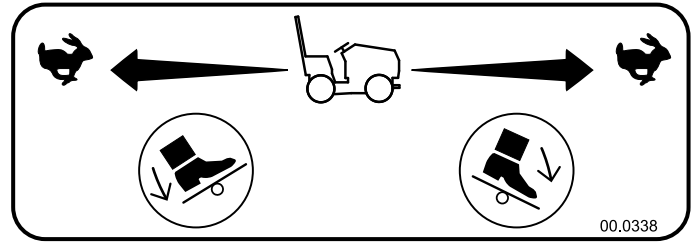

The foot pedal works in conjunction with the SDLA control lever and can be used to control the speed and direction of the power unit when the operator's hand is removed from the SDLA lever.

Press down on the front portion of the foot pedal to move the power unit in the forward direction. Press down on the rear portion of the foot pedal to move in the reverse direction. Changing the amount the foot pedal is depressed will change the ground speed of the power unit.

To slow or stop the power unit, press down on the opposite end of the foot pedal (i.e. if you are travelling forward, press down on the rear of the foot pedal).

Slope Indicator Gauge (NN)

The slope indicator gauge is designed to monitor the total slope angle of the terrain where the power unit is operating. Total slope angle combines side-to-side angle with front-to-back angle to provide a true overall measurement of slope angle, regardless of the power unit orientation. The slope gauge has slope limit set-points that can be changed to match the capability of the power unit configuration along with attachments that might limit the slope rating of the power unit. The slope gauge is equipped with both audible and visual alerts which can be set independently to warn the operator of limiting conditions. The display screen has multiple options to suit the operator preference.

Refer to the Slope Gauge Settings and Operation section for calibration, settings, and operation instructions.

OPERATIONAL CONTROLS

3 Point Hitch & Rear Auxiliary Control Handles (PP, QQ, and RR)

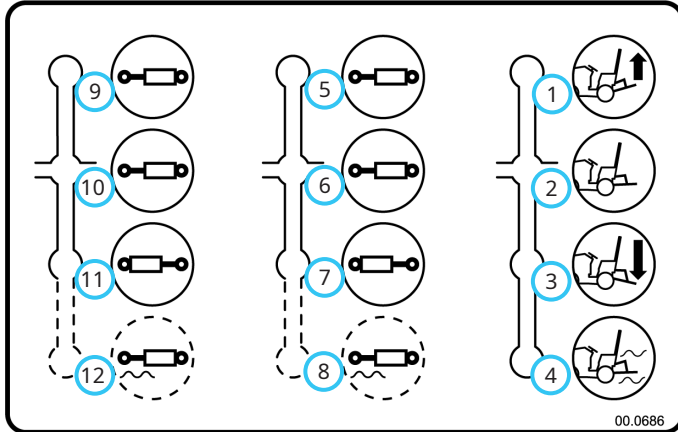

- | | |
|--|---|
| 1. 3 Point Hitch Lift | 8. Left Auxiliary Hyd. Couplers Float (if equipped) |
| 2. 3 Point Hitch Hold | 9. Right Auxiliary Hyd. Couplers Direction #1 |
| 3. 3 Point Hitch Lower | 10. Right Auxiliary Hyd. Couplers Hold |
| 4. 3 Point Hitch Float | 11. Right Auxiliary Hyd. Couplers Direction #2 |
| 5. Left Auxiliary Hyd. Couplers Direction #1 | 12. Right Auxiliary Hyd. Couplers Float (if equipped) |
| 6. Left Auxiliary Hyd. Couplers Hold | |
| 7. Left Auxiliary Hyd. Couplers Direction #2 | |

The left control handle (PP) controls the position of the 3 point hitch arms. Pull back on the handle to raise the 3 point hitch arms. Push the handle forward to lower the 3 point hitch arms. Float position is attained by pushing the handle forward until the float detent locks the handle in place.

The middle control handle (QQ) controls the left rear set of hydraulic quick couplers. Pull back on the handle to activate the attachment hydraulic cylinder in direction #1. Push the handle forward to activate the attachment hydraulic cylinder in direction #2.

The right control handle (RR) controls the right rear set of hydraulic quick couplers. Pull back on the handle to activate the attachment hydraulic cylinder in direction #1. Push the handle forward to activate the attachment hydraulic cylinder in direction #2.

Rear Auxiliary Control Handles (QQ and RR)

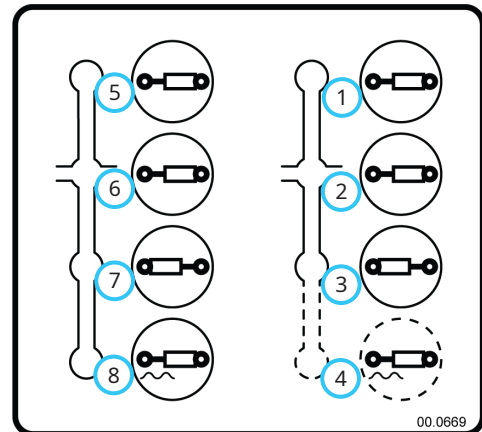

- | | |
|---|--|
| 1. Left Auxiliary Hyd. Couplers Direction #1 | 5. Right Auxiliary Hyd. Couplers Direction #1 |
| 2. Left Auxiliary Hyd. Couplers Hold | 6. Right Auxiliary Hyd. Couplers Hold |
| 3. Left Auxiliary Hyd. Couplers Direction #2 | 7. Right Auxiliary Hyd. Couplers Direction #2 |
| 4. Left Auxiliary Hyd. Couplers Float (if equipped) | 8. Right Auxiliary Hyd. Couplers Float (if equipped) |

The left control handle (QQ) controls the left rear set of hydraulic quick couplers. Pull back on the handle to activate the attachment hydraulic cylinder in direction #1. Push the handle forward to activate the attachment hydraulic cylinder in direction #2.

The right control handle (RR) controls the right rear set of hydraulic quick couplers. Pull back on the handle to activate the attachment hydraulic cylinder in direction #1. Push the handle forward to activate the attachment hydraulic cylinder in direction #2.

Rear Auxiliary Quick Couplers (SS)

The rear auxiliary hydraulic quick couplers are used to control auxiliary functions of attachments that are mounted on the rear of the power unit. The 3 point hitch and the rear hydraulic valve kit both include two sets of hydraulic quick couplers.

Back Up Alarm (TT)

The back up alarm emits an intermittent signal when the power unit is operated in reverse to alert nearby persons that the power unit is backing up.

OPERATIONAL CONTROLS

Seat Slide Lever (UU)

Lift up the seat slide lever to release the seat lock. Move the seat forward or backward to the desired position and release the seat slide lever to lock the seat in place.

Lumbar Support Knob (VV)

The lumbar support knob adjusts the curvature of the backrest in either the upper or lower part of the backrest.

Position 0 provides minimal support.

Position 1 provides maximum curvature in the upper part of the backrest.

Position 2 provides maximum curvature in the lower part of the backrest.

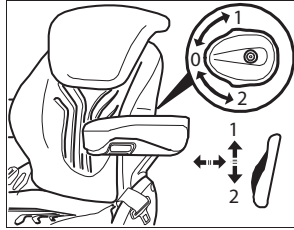

Backrest Angle Lever (WW)

Lift up the backrest angle lever to release the backrest catch. Move the backrest to the desired position and release the backrest angle lever to lock the backrest in place.

Weight Adjustment Lever (XX)

The weight setting must be adjusted with the operator sitting on the seat. The weight setting should be checked and adjusted as necessary each time the power unit is operated.

Fold the weight adjustment lever out and move it up or down to adjust the weight setting until the arrow is in the middle of the viewing window.

After adjusting the weight setting, fold the adjustment lever completely into the locking position.

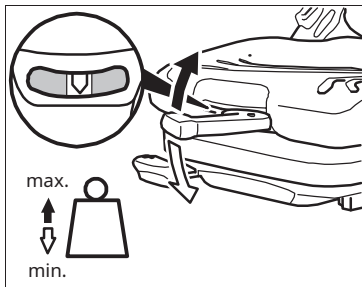

Heat Switch (YY)

Press the top of the heat switch to turn on the electric heating elements in the seat. Press the bottom of the heat switch to turn the heat off.

Optional Armrest Angle Knob (ZZ)

The angle of the optional armrests can be adjusted individually by rotating the knob on the underside of the armrest to raise or lower the front of the armrest.

Front Hitch Valve (BA)

The front hitch valve is used to control the lowering of the front hitch. Turning the knob on the front hitch valve counterclockwise (1) increases the speed at which the front hitch and attachment can be lowered. Turning the knob clockwise (2) decreases the speed at which the front hitch and attachment can be lowered.

The front hitch and attachment can be locked in any position, so that it will not lower, by turning the front hitch valve knob clockwise until it is completely closed. When operating 3 point hitch implements, it may be helpful to lock the front hitch and attachment in a raised position, to prevent accidental lowering of the front attachment.

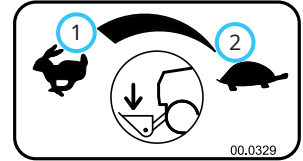

GENERAL OPERATION

Daily Inspection

⚠ WARNING

Always engage the parking brake, shut off the power unit engine, remove the ignition key, and ensure that all moving parts have come to a complete stop before inspecting the components, or attempting any repair or adjustment.

1. Park the machine on a level surface, with the engine shut off and all fluids cold.
2. Perform a visual inspection of the power unit. Look for loose or missing hardware, damaged components, or signs of wear.
3. Inspect the ROPS structure and seat belt for damage or signs of wear.
4. Inspect the battery, the electrical connections, and the lights.
5. Ensure the parking brake is set to the proper tension. Adjust the tension as required.
6. Inspect the hydraulic hoses and the hydraulic fittings to ensure tight, leak free connections.
7. Inspect the fuel lines to ensure tight, leak free connections.
8. Inspect the belts for damage or excessive wear. Refer to the Belt Inspection section of this manual.
9. Inspect the power unit's engine oil level, the hydraulic oil level, the coolant level, and the fuel level. Add fluid or service as required.

ATTENTION

If the power unit is equipped with a cab and heater kit and the outside air temperature is 4° C (40° F) or above, the radiator baffle must be removed and replaced with the radiator screen.

10. Ensure the radiator screen, the air cleaner, and the engine compartment are clean.
11. Check the tires for proper inflation.
12. Test the operator safety interlock system.

Starting the Engine

⚠ CAUTION

Use of ether or starting fluids may cause engine damage and/or personal injury. Do not use ether or starting fluids to aid in starting the engine.

The 4520 is equipped with an interlock system for operator safety. The safety interlock system requires the parking brake to be engaged and the SDLA lever to be in the neutral position for the power unit to start.

1. Turn the fuel shut-off valve to the On position.
2. Turn the battery disconnect switch to the On position.
3. Move the throttle lever to the half throttle position.

ATTENTION

Do not run the electric starter continuously for more than 5 seconds. If the engine does not start in this time, wait 15 seconds and try again.

4. Turn the ignition key to the start position and hold to engage the starter. Release the key when the engine starts. NOTE: if engine fails to start, refer to the troubleshooting section.

ATTENTION

Allow time for the hydraulic oil to circulate before operating the power unit. Failure to allow adequate warm up time may result in severe damage to the hydraulic system. Warm up time is increased in colder weather.

5. The engine and hydraulic oil must be warmed up before operating. Allow the power unit to run at approximately 1,800 rpm until the hydraulic filter is warm to the touch. The filter (A) is located to the inside of the left front fender.

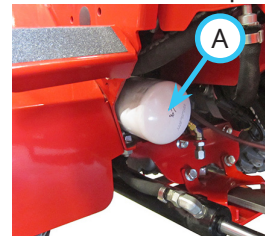

GENERAL OPERATION

Forward and Reverse

Set the neutral assist lever to the desired position. Verify that the intended path is safe and free from obstacles. When safe to move, begin by disengaging the parking brake.

⚠ WARNING

Do not remove your right hand from the SDLA control lever unless you are using an optional foot pedal to control the speed and direction. Forward/reverse direction, speed, and braking are controlled by the SDLA lever or the foot pedal. Your hand or foot must always be ready to brake or stop the power unit.

Power unit movement is controlled by moving the SDLA control lever in the desired direction of travel.

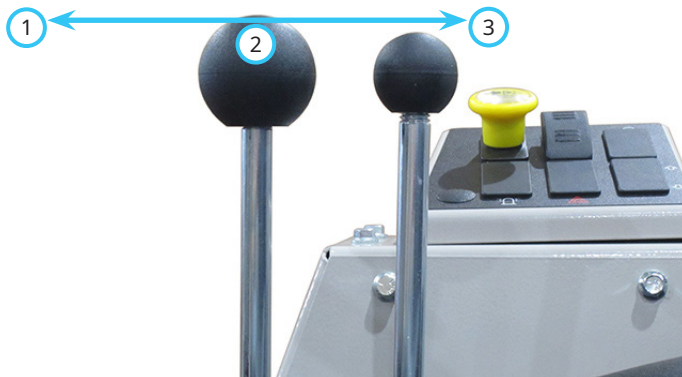

1. Forward 2. Neutral 3. Reverse

Push the SDLA control lever forward (1) to move the power unit in the forward direction. Pull the SDLA control lever backward (3) to move the power unit in the reverse direction. Changing the amount the SDLA control lever is moved changes the ground speed of the power unit. Moving the lever one half of the stroke will result in approximately one half of the maximum ground speed. Moving the lever to the end of the stroke will result in maximum ground speed.

If the power unit is equipped with an optional foot pedal, the foot pedal can be used to control the speed and direction instead of the SDLA control lever.

The SDLA control lever should be used for precision control in tight spaces or when connecting an attachment. The foot pedal is better suited to controlling speed and direction in open areas.

Stopping the Power Unit

To slow or stop the power unit, move the SDLA control lever or optional foot pedal toward the neutral position. Return the SDLA control lever or optional foot pedal to the neutral position to make a complete stop.

If in the case of an emergency, the power unit cannot be stopped with the SDLA control lever, pull back on the parking brake lever to engage the parking brake.

⚠ CAUTION

If the parking brake is engaged while the power unit is moving, the engine will shut off and the power unit will come to an abrupt stop.

Shutting Off the Engine

1. Park the power unit on a level surface and engage the parking brake.
2. Move the throttle lever to the slow idle position.
3. Allow the engine to idle for 3 - 5 minutes.
4. Turn the key to the Off position and remove the key from the ignition switch.
5. When parking the power unit at the end of the day, turn the battery disconnect switch and the fuel shut-off valve to the Off positions.

GENERAL OPERATION

Attaching

1. Drive the power unit slowly forward into the hitch arms of the attachment. Align the lift arms of the power unit with the attachment hitch arms by raising or lowering the front hitch and complete the engagement.
2. Once completely engaged, move the front hitch latch lever to the locked position. The latch (A) must lock over the attachment's hitch arm pin (B).
3. Engage the parking brake and shut off the engine.
4. Release the PTO belt tensioner rod*.
5. Place the attachment belt onto the PTO drive pulley on the power unit. Ensure the belt is properly seated in each pulley.
6. Engage the PTO belt tensioner rod.
7. Wipe the attachment hose ends* clean, and connect them to the power unit's hydraulic quick couplers. If equipped, connect the hoses and the quick couplers so the colored indicators are paired together (red to red, etc.).
8. Connect the attachment's electric plug* to the power unit's matching socket.

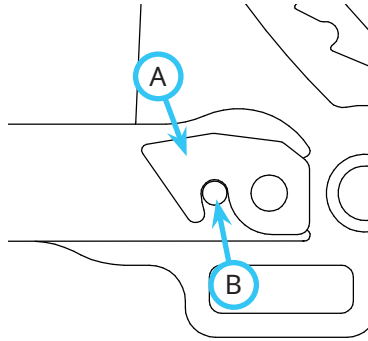

Detaching

1. Park the power unit on a level surface and engage the parking brake.
2. Fully raise the front hitch and set the weight transfer to 0 (if equipped).
3. Lower the attachment to the ground and place the primary SDLA lever in the float position.
4. Shut off the power unit engine.
5. Release the PTO belt tensioner rod*.
6. Remove the attachment belt from the PTO drive pulley of the power unit.
7. Move the secondary SDLA lever to the left and right to release pressure from the auxiliary hydraulic circuit and disconnect the attachment hoses* from the power unit.
8. Disconnect the attachment's electric plug* from the socket on the power unit.
9. Lift the front hitch lever lock to release the front hitch latch lever and move the front hitch latch lever to the unlocked position.
10. Restart the power unit and slowly back away from

the attachment. A side to side movement of the steering wheel may aid in disengagement.

*Applies only if the attachment is equipped.

Refer to the attachment manual for additional details.

Operating Attachments

Read and understand each attachment operator's manual before using the attachment.

Front Hitch

The front hitch is used to secure attachments to the power unit and to raise and lower the attachment. The raise, lower, and float functions of the front hitch are controlled by the primary SDLA control lever.

PTO Drive Belt and Pulley

If the attachment requires a drive belt, release the PTO belt tensioner rod and install the attachment belt around the drive pulley (A).

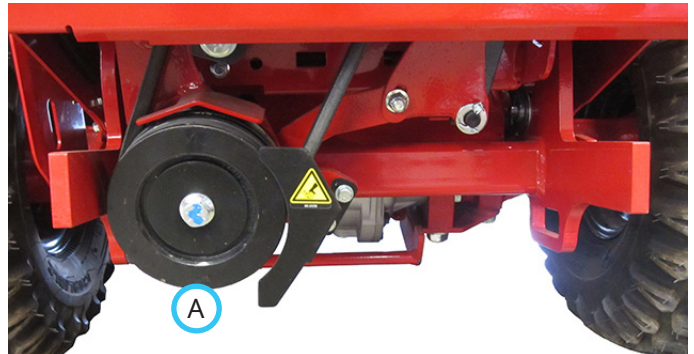

When the belt is in place around the drive pulley, push the PTO belt tensioner rod in to engage and tighten the belt.

GENERAL OPERATION

Front Auxiliary Couplers

CAUTION

Dirt and other debris in the hydraulic system can cause damage to the system. Wipe the mating parts of the couplers clean before attaching the hoses to the hydraulic couplers. Install the dust plugs in the hydraulic couplers when not in use.

If the attachment requires auxiliary hydraulics, couple the attachment hoses with the front auxiliary couplers. This is done by sliding the collar on the coupler rearward, inserting the male coupler of the attachment hose into the coupler, and then releasing the collar. If the collar will not snap forward on its own, pull it forward manually.

The couplers that the hoses are attached to will affect the direction the secondary SDLA lever is moved to control the action of the attachment. Connect the hoses to the quick couplers so the colored indicators are paired together (red to red, etc.).

The auxiliary couplers are controlled by moving the secondary SDLA lever to the left or right.

NOTE: pressure build-up in the attachment hoses and the power unit couplers may occur, causing difficult installation of the hoses. If the hoses do not easily connect, try one or both of the following steps.

1. To release pressure from the power unit couplers, shut off the engine and move the secondary SDLA lever to the left and right to release pressure in the power unit's hydraulic circuit.
2. To release pressure in the attachment hose, loosen the hose end and retighten after the pressure is released.

WARNING

Hydraulic fluid is under high pressure and can penetrate skin causing injury. Keep your hands, face, and body away from pinholes or nozzles that can eject hydraulic fluid under high pressure.

Weight Transfer

The weight transfer system transfers weight from the attachment to the front wheels of the power unit when the front hitch is in float or assists in lifting the attachment. The operator can select different weight transfer rates using the weight transfer select lever.

To set the weight transfer, raise the front hitch to its maximum height and move the weight transfer select lever to the desired position.

Selecting the proper amount of weight to transfer depends on the attachment, the ground conditions, and operator preference. A lightweight attachment (e.g. KA160 power blower) will not operate in float with full weight transfer on. With full weight transfer on and mowing in the float position, the mower may not lower quickly enough when mowing through uneven terrain. The power unit speed or the weight transfer rate must be reduced.

High/Low Range

CAUTION

Never shift range while under load, while moving, or while on a slope. Always ensure the shift lever is secured in the lock position at the end of the shift stroke. Always install the ball pin to prevent the shift lever from accidentally moving to the neutral position. Always use low range when operating on slopes of greater than 15 degrees.

Low range is recommended for most pulling, pushing, and slow travel. High range is ideal for transport and light duty tasks.

1. Park the power unit on level ground and engage the parking brake.
2. Remove the ball pin and move the shift lever to the desired range position.

ATTENTION

Occasionally the engagement of the transaxle gears is prevented by misalignment. Moving the steering wheel slightly to the right or left will move the gears enough to complete the engagement.

3. Reinstall the ball pin to lock the shift lever in place.

GENERAL OPERATION

Turning Radius

The 4520 power unit has three mounting positions for the steering cylinder that determine the power unit's turning radius.

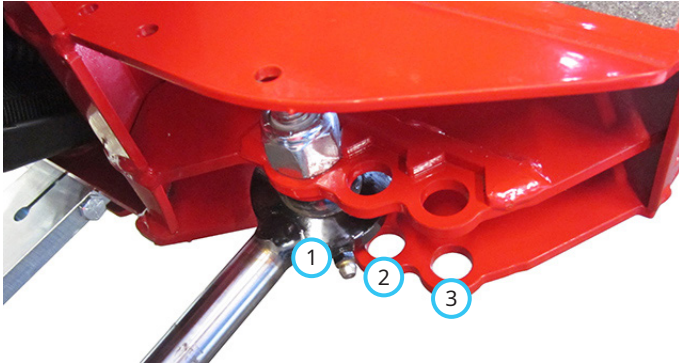

- 1. Standard position:** this position is the standard position and enables the tightest turning radius.
- 2. Dual wheel position:** the steering cylinder must be installed in this position when operating with dual wheels. The resulting turning radius is larger than position number 1.
- 3. Cab and Versa-loader position:** the steering cylinder must be installed in this position when a cab is installed or when operating the Versa-loader. The resulting turning radius is larger than position number 2.

Roll-Over Protection System

⚠ WARNING

Keep the ROPS locked in the upright position and the seat belt securely fastened during operation. Failure to do so could result in serious injury or loss of life.

The 4520 power unit is equipped with a fold down ROPS that allows the power unit to access areas of low overhead clearance. Lower the roll bar only when absolutely necessary and raise the roll bar to the upright position as soon as clearance allows.

⚠ WARNING

Do not wear a seat belt when the roll bar has been lowered to the down position.

To lower the roll bar:

1. Remove the pins from the right and left hinge plates (1).
2. Fold the roll bar down and install the pins in the hinge plates (2) to lock in place.

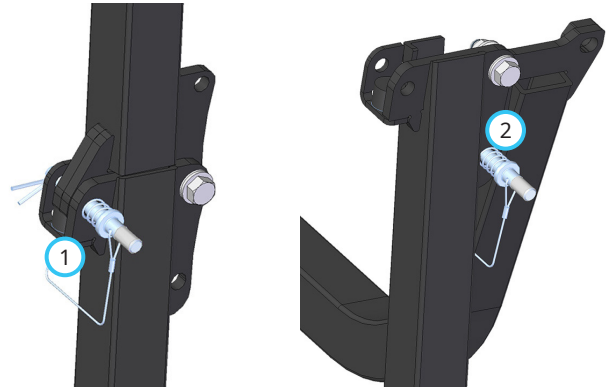

To raise the roll bar:

1. Remove the pins from the right and left hinge plates (2).
2. Raise the roll bar to the upright position and install the pins in the hinge plates (1) to lock in place.

GENERAL OPERATION

3 Point Hitch (Optional Accessory)

Some light and medium duty implements (non PTO powered) can be used on the rear of a 3 point hitch equipped power unit.

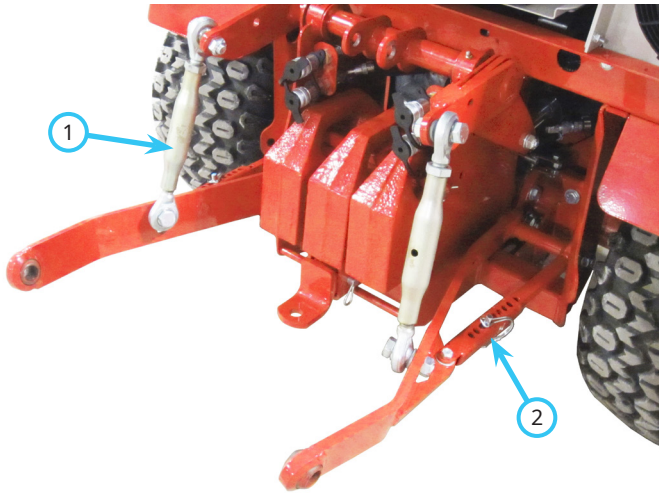

The optional 3 point hitch is equipped with adjustable lift links (1) to control the individual draw bars. The stabilizing links (2) can be allowed to swing freely or can be locked at a desired position.

The 3 point hitch is equipped with three control handles. The inner handle raises and lowers the draw bars. The middle handle controls the left rear set of hydraulic quick couplers. The outer handle controls the right rear set of hydraulic quick couplers.

12 Volt 4-Pin Auxiliary Sockets (Optional Accessory)

Certain attachments require 12 volt auxiliary power. Plug the attachment's 12 volt power cord into the 12 volt 4-pin socket. The actions of the front 12 volt socket are controlled by an on/off switch and two momentary on buttons on the SDLA handle. The actions of the rear 12 volt socket are controlled by an on/off switch and a momentary on/off/on switch on the panel behind the SDLA control levers. The momentary buttons or switch are used for controlling movement that is only used for a brief time. The on/off switches are used to activate equipment or to select different functions.

Directional/Hazard Flasher Operation (Optional Accessory)

The directional signal / hazard flasher lights are mounted on adjustable arms. They can be positioned with the arms up (1) for standard use or the arms can be rotated down (2) for use on power units equipped with dual wheels.

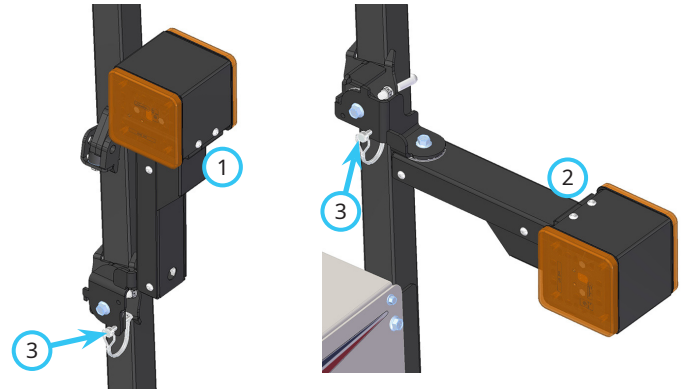

To change the light position, remove the lock pin (3), move the arm to the desired position, and reinstall the lock pin to secure in place.

The light is mounted to the pivot bracket using a friction washer that allows the light to pivot forward or backward when it contacts an object. If the arm gets knocked out of position, manually move the arm back into alignment.

GENERAL OPERATION

Operating On Slopes

⚠ WARNING

Operation on slopes decreases the power unit stability and increases the potential for unexpected difficulties. Only experienced operators should operate the power unit on slopes and extra caution should be exercised.

Use low range when operating on slopes greater than 15 degrees.

Never shift between high and low range while on a slope. Always move the machine to level ground and engage the parking brake before shifting range.

Avoid uneven, loose, or wet terrain.

Stay clear of drop-offs, holes, ditches, rocks, or objects that could cause a sudden and/or unexpected force on the power unit.

Make slow and cautious starts, stops, and turns.

Do not exceed the maximum degree of operation. Refer to the power unit capability illustrations.

Turn downhill when possible and/or reduce the degree of turns.

Ensure a sufficient supply of fuel for continuous operation. A minimum of one-half tank of fuel is recommended.

To prevent fuel spillage, do not remove the fuel tank cap while the power unit is on a slope.

Failure to follow safety instructions while operating on slopes can result in injury or death. Always use caution when operating on slopes.

ATTENTION

Maximum angle of operation for the engine (Kawasaki FD851D) in the 4520P power unit: 30° continuous.

Maintain sufficient fuel in the tank to ensure continuous operation.

Cease operation if the power unit stability is questionable, or if the operator is uncomfortable or unsure of continuing safely.

Attachments can affect the stability of the power unit. Each attachment will affect the power unit differently.

Increase the amount of weight being transferred to the power unit from the attachment while operating on slopes. Refer to the Weight Transfer section.

Always operate carefully and in a manner that does not compromise safety.

Always keep the roll bar in the upright, locked position and fasten yourself securely with the seat belt.

Refer to the following illustrations for power unit capability with different equipment options.

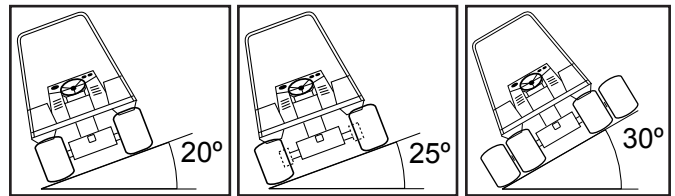

Single Tires

Wheel Extensions

Dual Wheels

Model	Single Tires	Wheel Extensions	Dual Wheels
	Any Direction		
4520	20°	25°	30°

⚠ WARNING

Some attachments or accessories have further limitations on the maximum angle of operation. Refer to the attachment operator's manuals for limitations.

GENERAL OPERATION

Slope Gauge Settings and Operation

⚠ WARNING

Do not attempt to enter or use the options menu while driving the power unit. Park the power unit in a safe location and engage the parking brake before entering the menu to make changes.

Always make sure the slope gauge is calibrated correctly and the slope limit set-points are set to match the power unit configuration prior to operating the power unit.

Never set the slope limit set-points for the audible or visual alerts to a higher value than the power unit configuration can safely handle. Refer to the Operating On Slopes section of this manual and the safety section of the attachment's manual to determine the correct slope limit.

When changing attachments and/or power unit configuration, always update the audible and visual warning set-points to reflect any changes to the maximum slope rating.

Be aware of whether the audible alarm is turned on (enabled) or muted.

Do not depend solely upon the slope gauge alarm to alert you to dangerous situations. Do not operate on slopes that make you feel uncomfortable.

Operation

The slope gauge is equipped with a sensor to the left of the display screen.

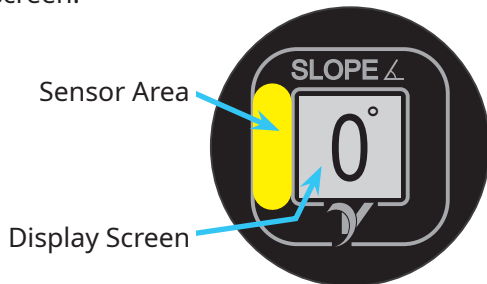

Hold your thumb over the sensor for the required time period to enter the options menu or to make a selection. Follow the instructions on the display screen.



Starting below the sensor area, swipe your thumb up across the sensor to scroll through options such as the audible or visual alert set-points or the display screen options.

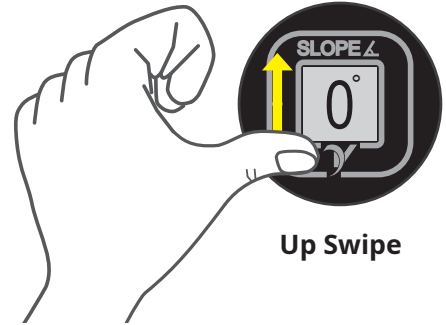

Tips for Selecting and Swiping

- Do not try to hold (select) or swipe while wearing gloves.
- After making a selection or swiping, move your hand away from the gauge before repeating. Swiping too fast or hovering your hand above the sensor area can cause unintentional input.
- If the sensor is not capturing your swipe movements, try increasing or decreasing the distance from the surface of the gauge, slowing down your motion, or using your entire hand instead of just your thumb.

Startup

Every time the power unit is started, the slope gauge will display a Ventrac splash screen, followed by the current set-points for the audible and visual alerts. The startup screen will also show whether the audible alarm is turned on (enabled) or muted.



Alarm
Enabled



Alarm
Muted

After displaying the startup screen, the slope gauge will return to the last selected display screen and display the current slope.

GENERAL OPERATION

Menu Options

To calibrate the slope gauge, change audible or visual alarm set-points, or to change the display screen, hold your thumb over the slope gauge sensor for eight seconds to enter the options menu. The option screens will display instructions for making changes to the current feature. Swipe up across the sensor to cycle through the menu screens. Each swipe advances one position to the next menu screen. The dots (A) at the top of the screen allow the user to see their screen position (highlighted dot) in the menu.

Menu Screen 1 allows the user to mute or enable the audible alarm. The screen will display the current state of the alarm. Hold over the sensor for three seconds to change the setting.

Menu Screen 2 changes the audible alarm set-point. Hold over the sensor until the set-point angle begins to flash. Swipe up across the sensor to cycle through the set-point options.



When the desired set-point is reached, hold over the sensor to save the setting.

Menu Screen 3 changes the visual alarm set-point. Hold over the sensor until the set-point angle begins to flash. Swipe up across the sensor to cycle through the set-point options.



When the desired set-point is reached, hold over the sensor to save the setting.

Menu Screen 4 calibrates the slope gauge. This zeros out the gauge at the current position. Refer to the slope gauge calibration section for calibration instructions.

Menu Screen 5 changes the screen display. There are five screen display options from which the operator can choose to display during operation. Hold over the sensor until the factory default screen is displayed. Swipe up to cycle through the display screen options.

Display Screen 1 is the factory default screen and it displays the total slope angle in degrees.

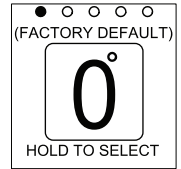

Display Screen 2 displays the total slope angle in degrees, along with the percentage of slope.

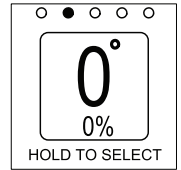

Display Screen 3 displays the total slope angle in degrees, along with a visual horizon and roll indicator.

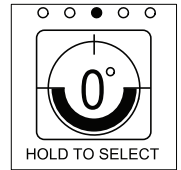

Display Screen 4 displays the total slope angle in degrees, along with independent front-to-back angle and side-to-side angle.

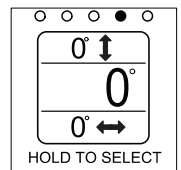

Display Screen 5 displays the total slope angle in degrees, along with independent front-to-back angle and side-to-side angle with position indicators.

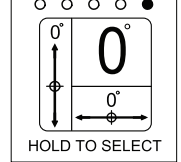

When the desired screen is reached, hold over the sensor to select and save. The slope gauge will remember the selected screen when the power unit is shut off and will display the selected screen when the power unit is restarted.

Menu Screen 6 resets the slope gauge back to the factory default settings. The audible alarm will be turned on, and the audible and visual set-points will be restored to 20 degrees. The slope gauge will need to be recalibrated before operating the power unit. Hold over the sensor until the screen changes to show the default audible and visual alarm settings. Hold over the sensor again until the screen changes to notify you that the reset was successful.

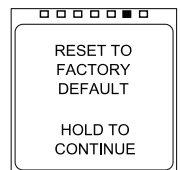

Menu Screen 7 exits the options menu. Hold over the sensor to exit and return to the display screen.



GENERAL OPERATION

Audible and Visual Alerts (70.4140 Gauge)

WARNING

Never set the slope limit set-points for the audible or visual alerts to a higher value than the power unit configuration can safely handle. Refer to the Operating On Slopes section of this manual and the safety section of the attachment's manual to determine the correct slope limit.

Before operation, determine the maximum slope rating for the power unit and attachment configuration. Change the set-points for the audible and visual alerts to match the maximum slope rating. If the power unit is used on a slope angle greater than the set angle, the audible alarm will sound (unless muted) and the display screen will flash a visual warning to alert the operator. If this occurs, slowly and carefully move the power unit off the slope.

70.4140 Slope Gauge Calibration

WARNING

The power unit must be parked on level, horizontal ground in order to be calibrated correctly. Always check to make sure the gauge is calibrated correctly prior to operating the power unit.

1. Park the power unit on a flat, level surface.
2. Shut off the power unit engine and lower any attachments to the ground.
3. Turn the ignition key to the Run position.
4. Enter the options menu and scroll to the calibration screen.
5. Hold your thumb over the sensor until the screen displays a warning message, then remove your thumb. If the requirements in the warning message are met, hold your thumb over the sensor again to perform the calibration.
6. When the screen changes to say calibration successful, remove your thumb from the sensor. The gauge will automatically return to the selected display screen.

Operation in Water, Mud, Snow, or Ice

WARNING

Operation in water, mud, snow, or ice decreases power unit traction and increases the potential for unexpected difficulties or loss of control. Reduce your speed and exercise caution.

WARNING

Operation on frozen bodies of water can be dangerous. The machine could fall through the ice and cause the operator to drown. Never operate on ice unless you have verified the thickness of the ice and that the travel path is safe.

CAUTION

Operation in water may cause damage to the hydraulic system, axles, or other parts. If the water level reaches the tire rim, the water is too deep.

Towing or Pushing the Power Unit

ATTENTION

Avoid damage to your power unit! Before towing, read and understand the following information. Severe damage will occur to the unit if the proper towing procedure is not followed.

CAUTION

Failure to place the transaxles in neutral when towing or pushing the power unit may result in damage to the power unit drivetrain.

If the power unit needs to be moved without the engine running, it is important to remember to place the transaxles in neutral by shifting the high/low range shift handle to the middle of the shift stroke. With the transaxles in neutral and the parking brake disengaged, the power unit can freewheel. Use extreme caution when towing or pushing the power unit as steering may not function. Do not exceed 8 km/h (5 mph). Be prepared to engage the parking brake to stop the power unit.

SERVICE

⚠ WARNING

Always engage the parking brake, shut off the power unit engine, remove the ignition key, and ensure that all moving parts have come to a complete stop before inspecting the components or attempting any repair or adjustment.

ATTENTION

Ventrac recommends that service of the power unit be performed by a qualified technician. If you are unsure how to perform the service procedure(s), contact your Ventrac dealer.

ATTENTION

If any component requires replacement, use only original Ventrac replacement parts.

Service and General Maintenance

Proper and timely service of this power unit is critical to keep the power unit in a safe and reliable operating condition. Follow the maintenance schedule at the end of the service section. For convenience, a frequent service guide decal and a quick reference decal have been placed on the power unit under the hood.

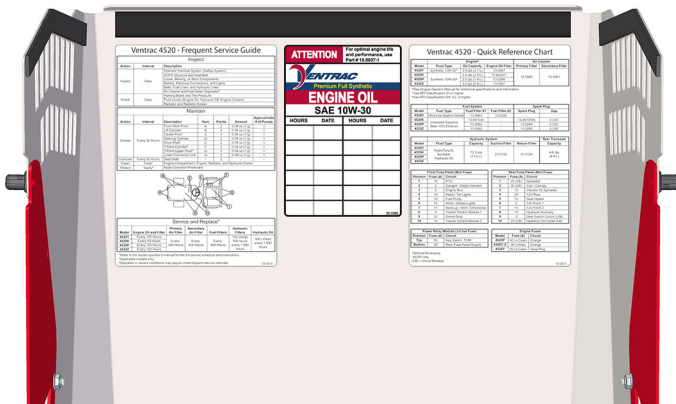

Cleaning and Appearance Care

For best results, and to maintain the finish of the power unit, clean or wash the power unit to remove accumulated clippings, leaves, dirt, gravel, and salt deposits when the job is finished.

ATTENTION

To maintain the finish of the power unit, thoroughly wash the equipment after each use to remove any corrosive agents (e.g. salt). Failure to clean the equipment may result in corrosion of (including but not limited to) steel, aluminum, and electrical components. Equipment that will experience repeated exposure to corrosive agents should be pretreated with a corrosion preventative.

⚠ CAUTION

If the engine has been running, it must be allowed to cool in order to prevent damage to the block and the exhaust manifold.

Do not direct high pressure water at the engine, air cleaner, muffler, radiator, hydraulic oil cooler, or any electrical components.

Allow the power unit and all components to cool before washing. Refer to the specific service sections for proper cleaning techniques for the engine, radiator, and hydraulic oil cooler. Use mild soap and water to clean the power unit. Harsh chemical cleaners could cause damage to the finish or the components.

It is necessary to periodically remove the lower rear frame cover and blow out or wash out any accumulated debris.

After cleaning, use touch up paint to repair any chips or scratches.

SERVICE

Service Access Points

Throughout the service chapter, various access points are referred to. The following list and images identify shields and covers that may need to be removed or opened during service.

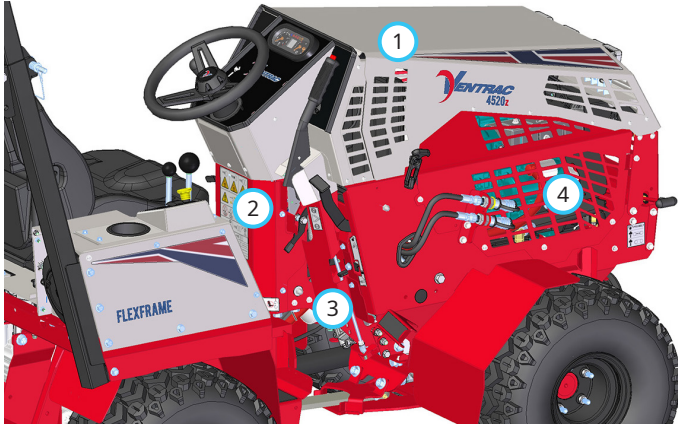

- 1. Engine Hood
- 2. Pump Cover
- 3. Right Pump Access Cover
- 4. Right Engine Cover



- 5. Control Panel
- 6. Left Engine Cover
- 7. Front Grill Plate

- 8. Seat
- 9. Lower Rear Frame Cover



10. Debris Barrier

Lubrication Locations

Lubrication is required at the following locations. Refer to the maintenance schedule for service intervals and the amount of grease. Refer to the fluid capacities and specifications section for the grease type.



Steering Cylinder and Connector Link

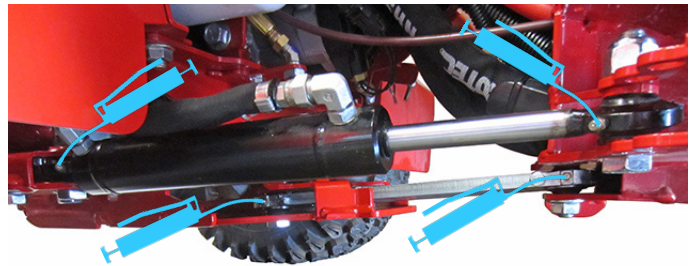

Front Hitch

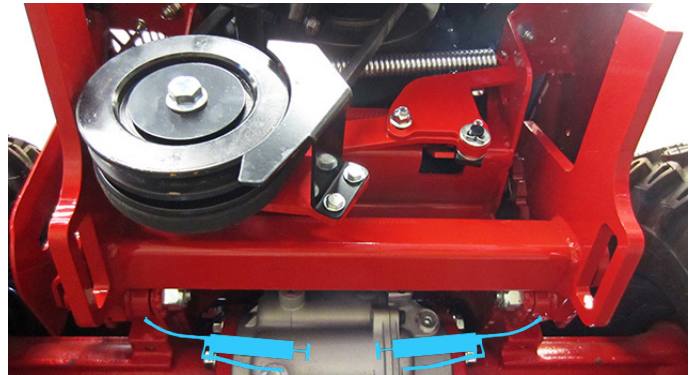

Lift Cylinder

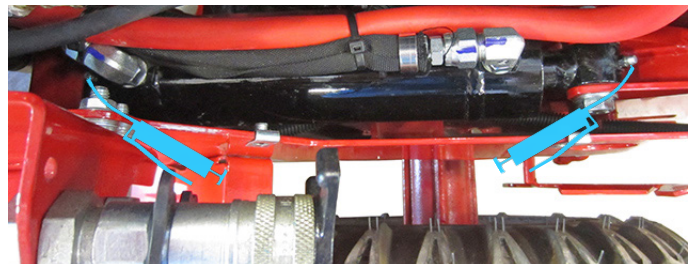

Ball Joint

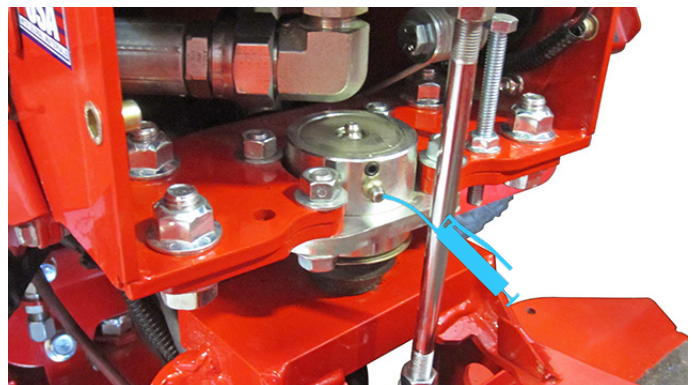

SERVICE

Drive Shaft

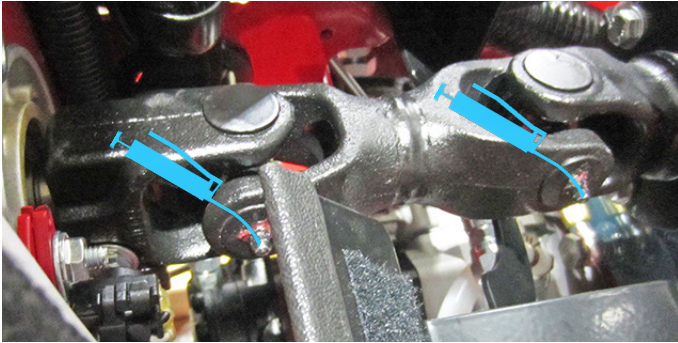

The front fitting of the drive shaft can be reached under the radiator, from the right side of the power unit, using a grease gun with a 33 cm (13 inch) or longer rubber hose. Remove the right engine cover and rotate the drive shaft so the grease fitting is pointed directly toward the right side of the power unit. Insert the hose from the right side, in line with the grease fitting. Push the hose onto the grease fitting and hold in place while greasing. The rear fitting can be reached by pulling back the canvas debris barrier to the rear of the radiator.

Seat Slide

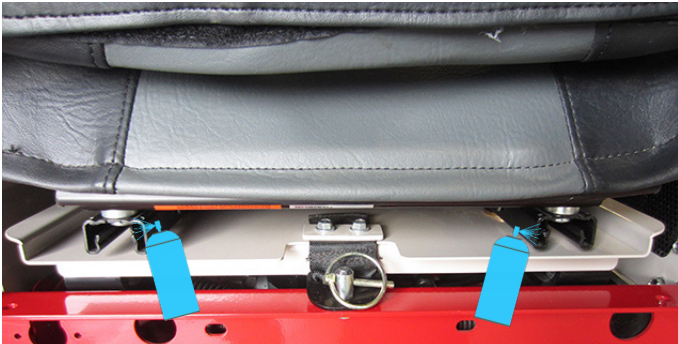

Optional 3 Point Hitch

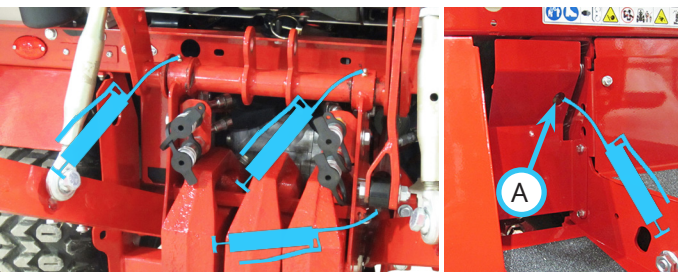

The front grease fitting on the 3 point cylinder can be greased through an access hole (A) in the right foot platform panel.

Checking the Hydraulic Oil Level

Check the hydraulic oil level when the hydraulic system is cold, prior to operating the power unit. If the hydraulic system is warm, allow one hour for the hydraulic system to cool before checking the oil level. Checking the oil level when the hydraulic system is warm will produce an inaccurate oil level reading.

ATTENTION

After connecting a new attachment or kit that runs off the power unit's hydraulic system, run the attachment through a complete cycle, then stop and check the hydraulic oil level.

1. Park the power unit on a level surface and adjust the steering to aim the power unit straight ahead.
2. Fully raise the front hitch and lower the 3 point hitch (if equipped).
3. Shut off the engine and allow time for the hydraulic system to cool.
4. The hydraulic oil tank (A) is located under the hood and dash.
5. Check the oil level in the plastic sight tube (B) next to the hydraulic oil tank. The oil level should be within the proper range indicated by the oil level decal on the hydraulic oil tank.
6. If the hydraulic oil level is below the low mark on the decal, add HydroTorq XL synthetic hydraulic oil until the proper level is reached.

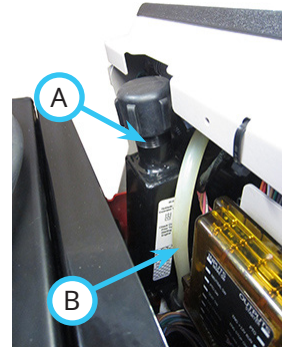

SERVICE

Checking the Rear Transaxle Oil

Check the rear transaxle oil level when the oil is cold, prior to operating the power unit.

1. Remove the rear weights from the hitch bar (if equipped).
2. Remove the oil fill plug (A) from the transaxle and check to see if the oil level is even with the bottom of the oil fill hole.
3. If the oil level is low, add Hydro-Torq XL synthetic hydraulic oil until the oil is level with the bottom of the oil fill hole.
4. Reinstall the plug into the rear transaxle and torque to 34-39 Nm (25-29 ft-lbs).
5. Clean up any spilled oil.
6. Reinstall the rear weights (if equipped).

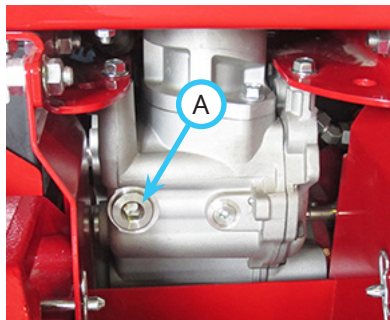

8. Place the drain pan under the right rear axle beneath the small hydraulic filter (B).
9. Use a strap type filter wrench to unscrew the filter from the filter head and allow the oil to drain into the pan.
10. Wipe the filter mounting surface with a clean cloth.
11. Apply a thin film of clean oil to the gasket of the new filter and screw onto the filter head until the gasket makes contact with the mounting surface. Tighten the filter an additional 1 turn (may require using a strap type filter wrench).
12. Clean up any spilled oil and dispose of oil and filters in accordance with local laws.

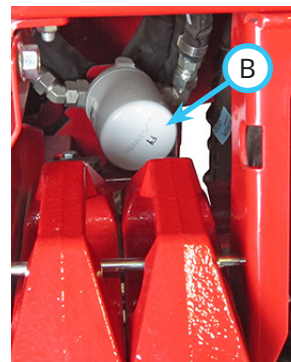

Changing the Hydraulic Oil Filters

1. If the power unit has been running, allow time for the hydraulic system to cool.

⚠ WARNING

Hot oil can cause severe burns. Allow the oil temperature to drop from hot to warm before changing the oil filters.

2. Remove the hydraulic filter access cover.
3. Clean the hydraulic filters, the filter heads, and the area around the filters.
4. Place a drain pan (minimum 3.8 liter / 4 quart) under the large hydraulic filter (A) in front of the left foot platform.
5. Use a strap type filter wrench to unscrew the filter from the filter head and allow the oil to drain into the pan.
6. Wipe the filter mounting surface with a clean cloth.
7. Apply a thin film of clean oil to the gasket of the new filter and screw onto the filter head until the gasket makes contact with the mounting surface. Tighten the filter an additional 3/4 of a turn (may require using a strap type filter wrench).

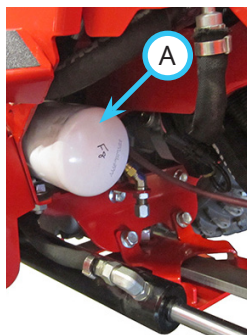

13. If the hydraulic oil is being changed at the same time as the filters, skip the remaining steps and proceed to the Changing the Hydraulic Oil section.
14. Add HydroTorq XL synthetic hydraulic oil to the hydraulic oil tank until the oil level in the plastic sight tube is within the proper range indicated by the oil level decal.
15. Start the power unit and let it run at low idle engine speed for a few minutes. Turn the steering wheel to the left and right a couple of times to purge any trapped air out of the hydraulic system.
16. Shut off the power unit engine and allow the power unit to sit for a minimum of five minutes.
17. Check the hydraulic oil level. Refer to the Checking the Hydraulic Oil Level section.
18. Inspect both of the hydraulic filters for signs of leakage. If any leaks are evident, the filter may need tightened further, or the filter may need to be removed, the gasket and filter mount cleaned, and the filter reinstalled following the procedures for changing the filter.
19. Reinstall the hydraulic filter access cover.

ATTENTION

Oil is hazardous to the environment. Drain oil into an approved container and dispose of used oil in accordance with local laws.

SERVICE

Changing the Hydraulic Oil

1. Wash the underside of both the front and rear transaxles thoroughly.
2. Park the power unit on a level surface and adjust the steering to aim the power unit straight ahead.
3. Fully raise the front hitch and lower the 3 point hitch (if equipped).
4. Shut off the engine and allow time for the hydraulic system to cool.

⚠ WARNING

Hot oil can cause severe burns. Allow the oil temperature to drop from hot to warm before draining the hydraulic oil.

5. Place a drain pan (minimum 13.5 liter / 14 quart) under the front transaxle.
6. Remove the drain plug (A) from the front transaxle and allow the hydraulic oil to drain from the system. Loosen the cap on the hydraulic oil tank to allow venting.

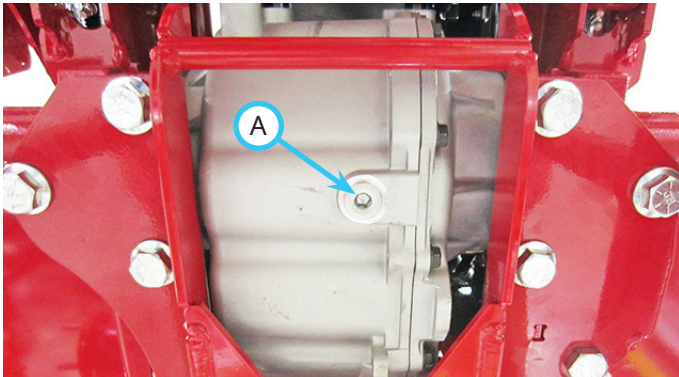

7. Reinstall the plug into the front transaxle and torque to 34-39 Nm (25-29 ft-lbs).
8. Clean up any spilled oil and dispose of oil in accordance with local laws.

ATTENTION

Oil is hazardous to the environment. Drain oil into an approved container and dispose of used oil in accordance with local laws.

9. If the hydraulic filters are being changed with the oil, proceed to the Changing the Hydraulic Oil Filters section before completing the remaining steps in this section.
10. Add HydroTorq XL synthetic hydraulic oil to the hydraulic oil tank until the oil level in the plastic sight tube is within the proper range indicated by the oil level decal.
11. Start the power unit and let it run at low idle

12. Shut off the power unit engine and allow the power unit to sit for a minimum of five minutes.
13. Check the hydraulic oil level. Refer to the Checking the Hydraulic Oil Level section.

SERVICE

Changing the Rear Transaxle Differential Oil

1. Remove the rear weights from the hitch bar (if equipped).
2. Place a drain pan (minimum 5.5 liter / 6 quart) under the rear transaxle.

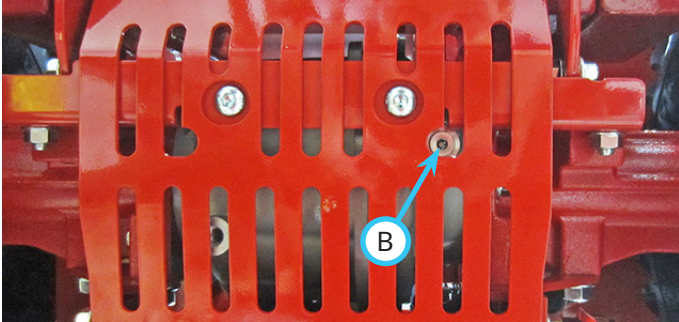

3. Remove the drain plug (B) from the rear transaxle and allow the hydraulic oil to drain. Remove the oil fill plug (C) from the rear transaxle to allow venting.

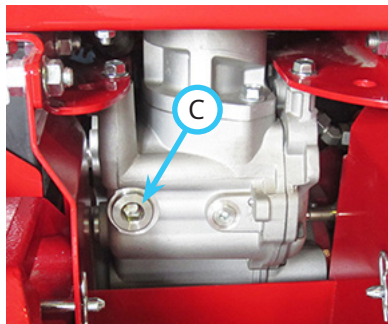

NOTE: on some power units, it may be necessary to remove the rear transaxle skid plate to access the drain plug.

4. Reinstall the plug into the rear transaxle and torque to 34-39 Nm (25-29 ft-lbs).
5. Add HydroTorq XL synthetic hydraulic oil (approximately 3.8 liters / 4 quarts) to the fill port in the rear transaxle until the oil is level with the bottom of the oil fill hole.
6. Reinstall the plug into the rear transaxle and torque to 34-39 Nm (25-29 ft-lbs).
7. Clean up any spilled oil and dispose of oil in accordance with local laws.

ATTENTION

Oil is hazardous to the environment. Drain oil into an approved container and dispose of used oil in accordance with local laws.

8. If the rear transaxle skid plate was removed to access the drain plug, reinstall the skid plate.
9. Reinstall the rear weights (if equipped).

Servicing the Closed Loop Hydrostatic Drive Circuit

ATTENTION

Service or repair of the closed loop drive circuit must be performed by an authorized Ventrac dealer. If any part of the closed loop hydrostatic drive circuit (the pump, the front drive motor, the rear drive motor, or any of the three 1/2" hydraulic lines connecting them together) is serviced or replaced, the Ventrac closed loop drive circuit filtration procedure must be performed. The procedure requires a special Ventrac remote filtering tool and must be performed by a Ventrac authorized technician.

Servicing the Hydraulic Cooler

1. Brush dirt and debris from the oil cooler screen in the right fender.
2. Remove the control panel from the top of the right fender.
3. Remove any accumulated debris from inside the fender area.
4. Blow the dust out of the cooler fins from inside the fender area using low pressure air.
5. Reinstall the control panel.

Checking the Engine RPM

Check the engine RPM when the engine is warm and not under load. Observe the tachometer:

- Low idle speed = 1,550 ±50 RPM
- High idle speed = 3,600 ±50 RPM

If engine RPM is incorrect, contact your Ventrac dealer.

SERVICE

Checking the Engine Oil Level

ATTENTION

Failure to check the engine oil regularly could lead to serious damage to your engine, if the engine is run with an incorrect oil level.

- Check the engine oil level with the power unit sitting on a level surface and with the engine shut off and the oil cold.
- Keep the oil level between the **Full** and **Add** marks.
- Do not add oil with the engine running.

1. If the power unit has been running, allow the engine and oil to cool.
2. Remove the oil dipstick (A) from the engine and wipe with a clean cloth.

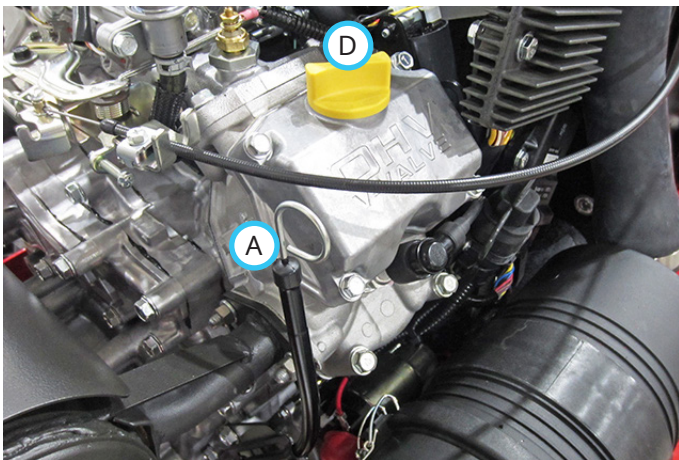

3. Insert the dipstick back into the engine and remove again.
4. Check the oil level. The level should be between the Full (B) and Add (C) marks on the dipstick.



5. If the oil level is low, remove the oil fill cap (D) and add small amounts of engine oil to bring the oil level no higher than the Full (B) level on the dipstick.
6. If the oil level is above the Full (B) mark, drain some engine oil to achieve the proper level.
7. Reinstall the dipstick and the oil fill cap.

Changing the Engine Oil and Filter

CAUTION

Contact with engine oil can irritate your skin. Wear protective gloves when working with engine oil. If you come in contact with engine oil, wash it off your skin immediately.

ATTENTION

Oil is hazardous to the environment. Drain engine oil into an approved container. Dispose of used engine oil in accordance with local laws.

1. Start the power unit engine and allow it to run until the engine reaches operating temperature.
2. Park the power unit on a level surface.
3. Shut off the engine and allow the engine to cool from hot to warm.

WARNING

Hot engine oil can cause severe burns. Allow the engine temperature to drop from hot to warm before draining the engine oil.

4. Remove the right engine cover to access the oil filter.

5. Place a drain pan underneath the oil drain (A) located beside the hydraulic oil filter on the left side of the power unit.

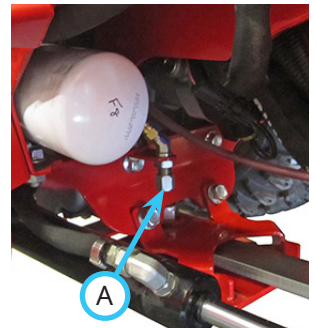

6. Remove the drain cap from the oil drain and drain into the pan while the oil is warm.

7. Remove the oil filter (B) located on the side of the engine.

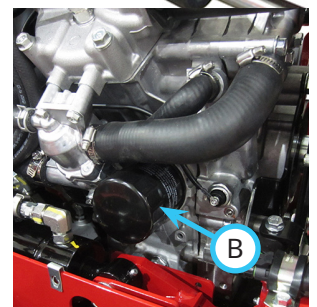

8. Wipe the filter mounting surface with a clean cloth.
9. Apply a thin film of clean oil to the gasket of the new oil filter.
10. Screw the new filter onto the engine until the gasket makes contact with the mounting surface. Tighten the filter 1/2 to 3/4 turn more by hand.
11. Install the drain cap onto the oil drain. Do not overtighten.
12. Remove the oil fill cap.

SERVICE

13. Add oil to the engine. Refer to the Engine Owner's Manual for proper oil specifications and capacity.

ATTENTION

For optimal engine life and performance, use Ventrac full synthetic engine oil (Part Number 15.0037-1).

14. Install the oil fill cap and wipe up any oil spills.
15. Start the power unit and let it run at low idle engine speed for approximately two to three minutes.
16. Shut off the engine and remove the ignition key.
17. Check for leaks around the oil filter. If any leaks are evident, the filter may need tightened further, or the filter may need to be removed, the gasket and filter mount cleaned, and the filter reinstalled.
18. Check the engine oil level after allowing the engine to cool for approximately two minutes and add oil if necessary.
19. Reinstall the right engine cover.

Changing the Air Filter Elements

ATTENTION

When both air filter elements are removed, an opening is created to the internal parts of the engine.

Be sure nothing falls into the canister that could make its way into the engine. Have the new filter elements ready to install immediately after removing the old filter elements.

Improper service to the engine air filter can result in severe engine damage.

- Inspect the filter daily in extreme heat, dust, or other severe conditions.
- Never run the engine without a proper air filter installed.
- Never wash or clean the paper filter element.

1. If the power unit has been running, allow the engine to cool.

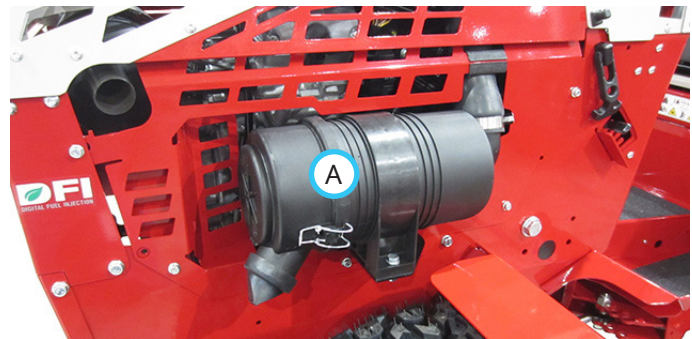

2. Release both latches (B) on the engine air filter assembly (A) and unhook the latches from the main filter housing.

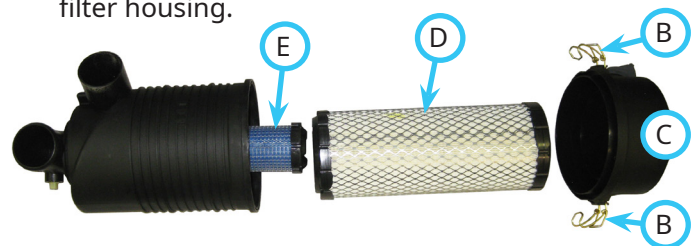

3. Remove the filter cap (C).
4. Remove and discard the primary (outer) air filter element (D).
5. If the safety (inner) air filter element (E) is scheduled for replacement, remove and discard the safety air filter element.
6. Install the new air filter element(s).
7. Reinstall the filter cap and fasten both latches.

SERVICE

Filling the Fuel Tank

⚠ DANGER

Fuel is flammable and explosive. Follow all safety instructions in the Fuel Safety section and in the Engine Owner's Manual.

⚠ WARNING

Long term exposure to fuel vapors can cause serious injury or illness. Avoid prolonged breathing of fuel vapors.

If fuel is spilled on your skin or clothing, change your clothing and wash the affected area immediately.

ATTENTION

Improper fuel can damage your engine. Only use fuel that meets the fuel grade and specifications listed in the Engine Owner's Manual.

1. Park the power unit on a level surface.
2. If the power unit has been running, allow the engine to cool.
3. The fuel tank cap is located on top of the left rear fender. Wipe any dust and dirt off the fuel cap to prevent dirt from falling into the fuel tank and remove the fuel cap.
4. Add fuel to the tank until the fuel level reaches the bottom of the fuel neck*. Do not overfill the tank by filling the fuel neck, as this may cause engine flooding, fuel leakage from the tank, and/or damage to the emissions control system. Keep the fuel nozzle in contact with the rim of the fuel neck until fueling is completed.
5. Replace the fuel cap and tighten.
6. Wipe up any fuel spills and allow fuel vapors to dissipate before starting the engine.

*If the power unit will not be used after filling the fuel tank, only fill the tank to within 25 mm (1 inch) of the bottom of the fuel neck to allow room for fuel expansion from temperature changes. Failure to do so may cause engine flooding, leakage from the tank, and/or damage to the emissions control system.

Changing the In-line Fuel Filter

1. Turn the fuel shut-off valve to the Off position.
2. Remove the lower rear frame cover.
3. Loosen the hose clamps and remove the fuel filter (A).
4. Install the new fuel filter with the arrow pointing toward the engine and fasten securely with the hose clamps.
5. Turn the fuel shut-off valve to the On position.
6. Inspect the fuel filter hose connections for leaks.
7. Reinstall the lower rear frame cover.

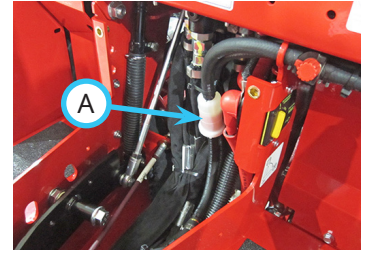

Priming the Fuel System

1. Turn the ignition key to the run position for approximately 30 seconds. The operator should hear the fuel pump operating.
2. Start the power unit. Repeat step 1 if necessary.

Cleaning the Engine Compartment and Engine

Clean the engine compartment and the engine daily or prior to each use, to reduce the risk of the engine overheating or the ignition of accumulated debris.

1. If the power unit has been running, allow the engine to cool.
2. Remove the left and right engine covers.
3. Remove accumulated debris and dust from the engine compartment and the engine.
4. Clean the radiator and radiator screen. Refer to the Cleaning the Radiator and Screen section.
5. Reinstall the left and right engine covers.

SERVICE

Servicing the Cooling System

⚠ WARNING

Discharge of hot, pressurized coolant or touching a hot radiator and surrounding parts can cause severe burns.

- Do not remove the radiator cap when the engine is hot. Always allow the engine to cool for at least 15 minutes or until the radiator is cool enough to touch without burning your hand before removing the radiator cap.
- Do not touch the radiator or surrounding parts that are hot.

⚠ WARNING

Wear personal protective equipment to protect your eyes and hands when opening the radiator cap to protect against any pressure in the radiator.

If coolant is spilled on your skin or clothing, change your clothing and wash the affected skin immediately.

⚠ DANGER

Engine coolant can cause poisoning.

- Do not swallow engine coolant.
- Keep out of reach from children or pets.

ATTENTION

Using an incorrect coolant mixture and/or type can cause engine damage. Use only a mixture of 50 percent distilled water and 50 percent ethylene glycol antifreeze.

Recommended antifreeze: a low silicate, phosphate free antifreeze (ethylene glycol) containing supplemental coolant additives (SCAs) to inhibit corrosion and rust

Dye color does not determine the antifreeze properties. Ethylene glycol antifreeze of different colors can be mixed.

Checking the Cooling System

1. Park the power unit on a level surface.
2. If the power unit has been running, allow the engine to cool.
3. Remove the cap (A) and check the coolant level in the coolant recovery tank. When the system is cold, the coolant recovery tank should be approximately half full of coolant.

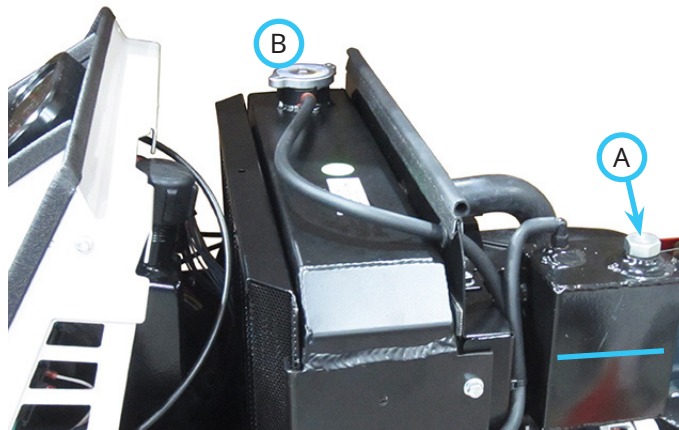

4. If the coolant level is low, add coolant to the tank and reinstall the cap.
5. If the coolant recovery tank is empty, slowly open the radiator cap (B) to the first stop and allow any pressure to release. Press down on the cap slightly and turn to remove the cap from the radiator.
6. Check to ensure the coolant level is up to the bottom of the fill neck.
7. If the coolant is low, add coolant to the radiator until it reaches the bottom of the fill neck.
8. Install the radiator cap.
9. Inspect the radiator hoses and clamps for leaks and deterioration. Replace as needed.

SERVICE

Cleaning the Radiator and Screen

1. If the power unit has been running, allow the engine and radiator to cool.
2. Remove the radiator screen (A).
3. Remove debris from the radiator screen using a brush, compressed air, or water.
4. When required, clean debris from the radiator using low pressure compressed air.
5. Check the radiator fins for damage.
6. Install the radiator screen.



Draining the Cooling System

ATTENTION

Coolant is poisonous to humans and animals and hazardous to the environment. Drain coolant into an approved container. Dispose of used coolant in accordance with local laws.

1. Park the power unit on a level surface.
2. If the power unit has been running, allow the engine to cool.
3. Remove the right engine cover to access the radiator drain.
4. Slowly open the radiator cap to the first stop to allow any pressure to release.
5. Place a drain pan or jug under the right side of the front frame.
6. Install an 11 mm (7/16 inch) ID hose (A) onto the radiator drain port (B) and route down to the drain pan.
7. Turn the drain valve counterclockwise to open and drain the coolant into the drain pan.

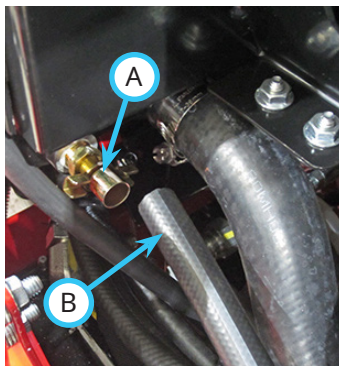

Flushing the Cooling System

1. Drain the cooling system.
2. Close the radiator drain valve, leaving the drain hose in place.
3. Add one can of radiator flush to the radiator and fill the radiator with clean water.
4. Install the radiator cap, start the engine, and run until the engine reaches operating temperature (71-82° C / 160-180° F).
5. Shut off the engine and remove the ignition key.

⚠ WARNING

Hot coolant can cause severe burns. Allow the temperature of the radiator to drop from hot to warm before draining the coolant.

6. Carefully drain the cooling system while the coolant is still warm.
7. Allow the engine and radiator to cool completely.

ATTENTION

Adding cold water to a hot engine can cause engine damage. Allow the engine and radiator to cool completely before adding water.

8. Add clean water to the radiator and allow the water to run through the system. Add more water as needed, until the water flowing from the drain valve is clear and free of sediment.
9. After the water has drained completely, close the drain valve and remove the drain hose.
10. Slowly add the new coolant mixture to the radiator until the level reaches the bottom of the fill neck. NOTE: residual water may be present in the radiator and the engine block. Adjust the coolant mixture to achieve a 50/50 ratio of coolant to water.
11. Install the radiator cap, start the engine, and run until the engine reaches operating temperature (71-82° C / 160-180° F).
12. Shut off the engine and allow the engine to cool.
13. Recheck the coolant level when the engine is cold. Add additional coolant if needed.
14. Install the right engine cover.

SERVICE

Servicing the Battery

⚠ DANGER

The battery produces a flammable and explosive gas. The battery may explode.

- Wear eye protection and gloves.
- Do not smoke near the battery.
- Keep arcs, sparks, and open flames away from the battery.
- Do not allow direct metal contact across the battery posts.
- Remove the negative battery cable first when disconnecting the battery.
- Install the negative battery cable last when connecting the battery.

⚠ WARNING

Battery electrolyte contains sulfuric acid. It is poisonous and can cause severe chemical burns.

1. Wear eye and skin protection.
2. If battery electrolyte is spilled on your skin or clothing, change your clothing and wash the affected skin immediately. Seek medical attention, if necessary.
3. If battery electrolyte is splashed into your eyes, flush immediately with water for 15-30 minutes and seek immediate medical attention.
4. If battery electrolyte is swallowed, get medical attention immediately. Drink large quantities of water, followed by Milk of Magnesia, beaten egg, or vegetable oil. DO NOT induce vomiting.

ATTENTION

Batteries contain poisonous and hazardous substances. Dispose of used batteries in accordance with local laws.

Removing the Battery

1. Tilt the seat forward and fasten in place with the seat prop.
2. Remove the left foot platform panel (A).
3. Disconnect the negative (-) battery cable (B).
4. Disconnect the positive (+) battery cable (C).

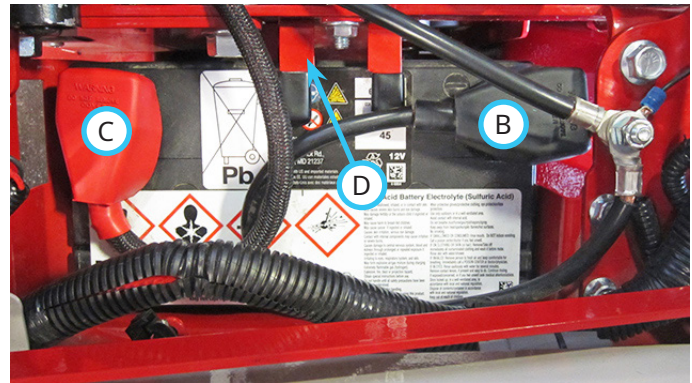
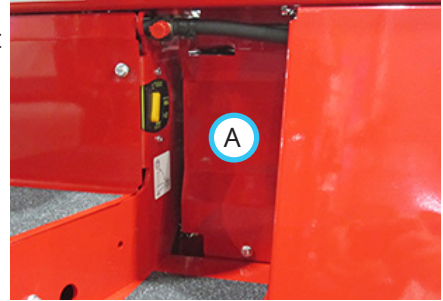

5. Remove the battery retainer (D).
6. Slide the battery forward out of the battery compartment.

Installing the Battery

1. Slide the battery into the battery compartment with the negative (-) post to the rear.
2. Install the battery retainer and torque the bolt to 24 Nm (210 in-lbs).
3. Install the left foot platform panel and torque the bolt to 11 Nm (100 in-lbs).
4. Connect the positive (+) battery cable to the positive battery post first.
5. Connect the negative (-) battery cable to the negative battery post last.
6. Apply dielectric grease to the battery terminals to prevent corrosion.
7. Place the covers back over the battery terminals.

SERVICE

Cleaning the Battery and Terminals

1. Remove the battery from the power unit.
2. Wash the battery with a solution of 60 mL (4 table-spoons) of baking soda to 3.8 liters (1 gallon) of water. Do not allow the soda solution to get into the battery cells.
3. Rinse the battery with clean water.
4. Clean the battery posts and battery cable terminals with a wire brush.
5. Reinstall the battery.

Charging the Battery

⚠ DANGER

Batteries produce explosive gases. Charge the battery in a well ventilated area where the gases produced by charging can dissipate. Do not charge where the battery could be exposed to sparks, open flames, or other sources of ignition.

Never charge a frozen battery, as it may explode. Allow the battery to warm up and inspect for cracks or damage before charging.

To preserve optimum battery performance and life, do not allow the battery to stand in a discharged state for long periods of time. If the battery is not being used, check the battery voltage every 30 days and recharge the battery if the voltage drops to 12.4 volts or lower.

Keep the battery fully charged in cold weather to prevent damage due to freezing.

1. If possible, remove the battery from the power unit before charging.
2. Refer to the battery charger's manual for specific charging instructions.
3. If electrolyte is expelled or excessive gassing occurs, or if the temperature of the battery exceeds 52° C (125° F), charging must be temporarily stopped to permit cooling. After cooling, reduce the charging rate before starting the charger again.

Jump Starting Procedure

⚠ DANGER

The battery produces a flammable and explosive gas. The battery may explode.

- Wear eye protection and gloves.
- Do not jump start a cold or frozen battery. Allow the battery to warm up and inspect for cracks or damage.
- Do not jump start a cracked or damaged battery.
- Do not attempt to jump start the power unit using a battery of a different voltage.

1. Inspect the discharged battery for terminal corrosion and loose connections. Clean the terminals and tighten the connections prior to jump starting.
2. Make sure the vehicle used to jump start the power unit has a 12 volt, negative ground, electrical system.
3. Pull the boosting vehicle up close to the disabled power unit. Be sure the vehicles do not touch.
4. Shut off the boosting vehicle's engine and engage the parking brake.

ATTENTION

Attempting to start the disabled unit with the boosting vehicle's engine running could cause damage to the regulator.

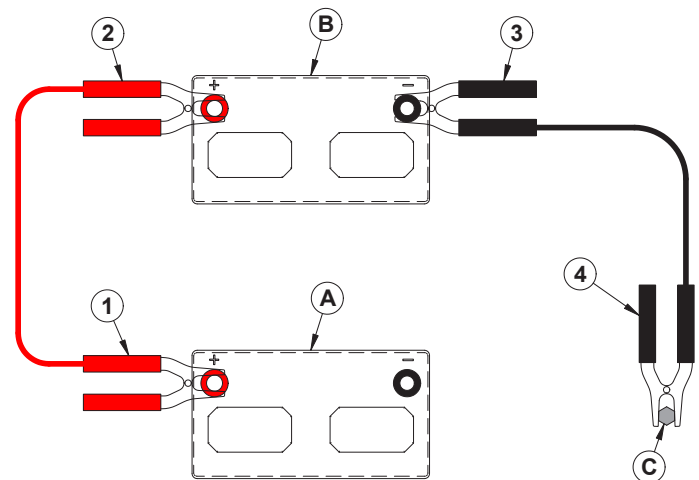

A. Discharged Battery C. Ground Stud
B. Booster Battery

5. Connect one end of the positive (+) booster cable to the positive (+) terminal (1) of the discharged battery.

SERVICE

6. Connect the other end of the positive (+) booster cable to the positive (+) terminal (2) of the booster battery.
7. Connect the negative (-) booster cable to the negative (-) terminal (3) of the booster battery.
8. Connect the other end of the negative (-) booster cable to the disabled power unit's ground stud (4).
9. Start the disabled power unit and remove the booster cables in reverse order of installation (negative booster cable first).

TCS (Tractor Control System) Explanation

The tractor control system controls the electronic safety related functions of this power unit. Both solid state and mechanical components are used to ensure the safe, reliable operation of this machine.

This TCS monitors the electronic circuits necessary for the engine, the starter, and the PTO to function. These input circuits include the PTO switch, the neutral switch, the parking brake switch, the ignition switch, and the seat switch. The TCS allows the engine, the starter, or the PTO to operate only when specific input criteria are satisfied. The engine, the starter, and the PTO are controlled by outputs from the TCS.

Replacing Fuses (Power Relay Module)

1. Turn the battery disconnect switch to the Off position.
2. Tilt the seat forward and fasten in place with the seat prop.
3. Remove the sealed fuse cap from the power relay module.
4. Identify and remove the defective fuse from the socket.

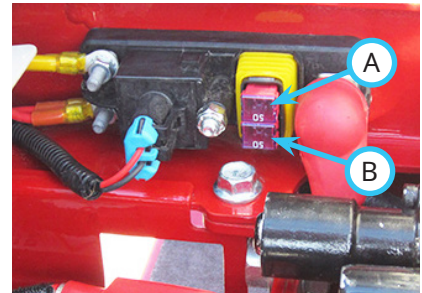

Power Relay Module (J-Case Fuse)

Position	Fuse	Circuit
Top (A)	50 amp	Key Switch, TCS
Bottom (B)	50 amp	Rear Fuse Panel Supply

5. Insert a new fuse into the socket. Be sure the fuse is the correct amperage or damage may occur to the power unit.
6. Reinstall the sealed fuse cap and lower the seat back down to the operating position.
7. Turn the battery disconnect switch to the On position.

SERVICE

Replacing Fuses (Front Fuse Panel)

1. Turn the battery disconnect switch to the Off position.
2. Remove the sealed cover (A) from the fuse panel.

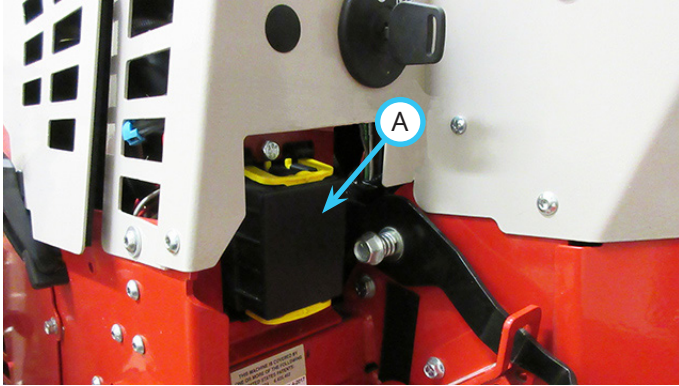

3. Identify and remove the defective fuse from the socket. Refer to the Quick Reference decal under the hood for fuse locations.
4. Insert a new fuse into the socket. Be sure the fuse is the correct amperage or damage may occur to the power unit.
5. Reinstall the sealed cover onto the fuse panel.
6. Turn the battery disconnect switch to the On position.

Replacing Fuses (Rear Fuse Panel)

1. Turn the battery disconnect switch to the Off position.
2. Tilt the seat forward and fasten in place with the seat prop.
3. Remove the sealed cover (A) from the fuse panel.

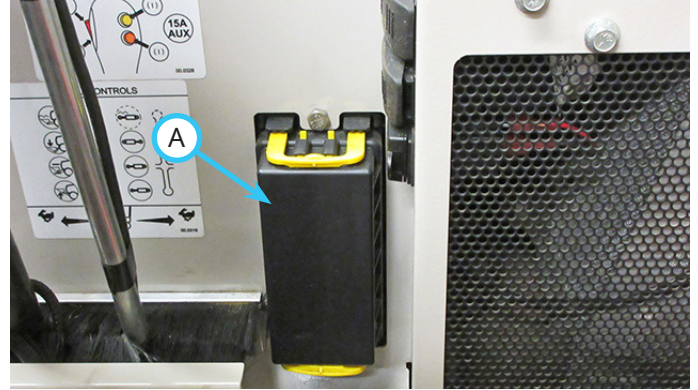

4. Identify and remove the defective fuse from the socket. Refer to the Quick Reference decal under the hood for fuse locations.
5. Insert a new fuse into the socket. Be sure the fuse is the correct amperage or damage may occur to the power unit.
6. Reinstall the sealed cover onto the fuse panel and lower the seat back down to the operating position.
7. Turn the battery disconnect switch to the On position.

SERVICE

Replacing Fuses (Engine)

1. If the power unit has been running, allow the engine to cool.
2. Turn the battery disconnect switch to the Off position.
3. Remove the left engine cover.
4. Locate the fuse holder (A) and pull up on the tab to remove the cover.

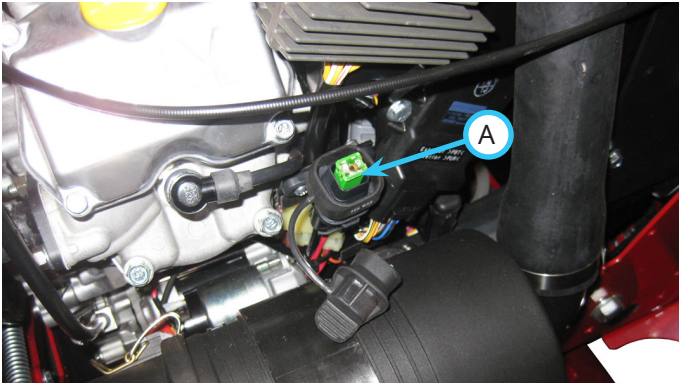

Engine Fuses		
Position	Fuse	Circuit
A	40 amp J-Case	Charge

5. Remove the defective fuse from the socket.
6. Insert a new fuse into the socket. Be sure the fuse is the correct amperage or damage may occur to the power unit.
7. Reinstall the fuse cover.
8. Reinstall the left engine cover.
9. Turn the battery disconnect switch to the On position.

Switching the Speedometer (mph or km/h)

The wire harness connection for the speedometer is under the right side of the dash near the warning alarm. Locate the green wire (labeled B-144) with an individual plug.

1. For a speedometer readout in miles per hour, the green wire (B-144) should be connected to the wire from the information gauge that is labeled B-142.
2. For a speedometer readout in kilometers per hour, the green wire (B-144) should be connected to the wire from the information gauge that is labeled B-143.

Replacing the Head Lights

The head lights are equipped with LEDs and do not use a replaceable bulb. If a head light no longer functions, the entire work light must be replaced.

Replacing the Tail Lights

The tail lights are equipped with LEDs and do not use a replaceable bulb. If a tail light no longer functions, the entire tail light must be replaced.

Replacing the Work Lights

The work lights are equipped with LEDs and do not use a replaceable bulb. If a work light no longer functions, the entire work light must be replaced.

Replacing the Turn Signal Lights

The signal lights that are used for the turn signal / hazard flasher kit are equipped with LEDs and do not use a replaceable bulb. If a signal light no longer functions, the entire light must be replaced.

Replacing the Strobe Light(s)

Both the ROPS mounted strobe light and the canopy strobe lights are equipped with LEDs and do not use a replaceable bulb. If a strobe light no longer functions, the entire strobe light must be replaced.

Changing the ROPS Strobe Light Flasher Mode

1. Remove the four screws that fasten the strobe light to the strobe light frame.
2. Locate the yellow wire from the strobe light. This wire is used to cycle the strobe light modes.
3. Turn the ignition key to the On position to turn on accessory power.
4. Turn the strobe light switch to the On position.
5. Insert the bare end of the yellow wire into the back of the terminal on the red power supply wire. Each time you touch the yellow wire against the red wire,

SERVICE

the strobe will change modes.

- When the desired mode is reached, turn the strobe light switch to the Off position and turn the ignition key to the Off position.
- Reinstall the strobe light back onto the strobe light frame.

Canopy Strobe Light Synchronization

If a light requires replacement, the strobe lights will need to be synchronized after the new light is installed and the flash pattern may need to be reset.

- Turn the power unit ignition key to the engine run position. Do not start the engine.
- Turn the strobe light switch to the On position.
- In the left rear corner of the canopy, locate the harness connector with a cap.
- Remove the cap from the connector.
- Use a jumper wire to connect the two terminals for seven seconds.
- Remove the jumper wire.
- Proceed to changing the flash pattern.

Changing the Canopy Strobe Light Flasher Mode

The strobe lights have seventeen different flash patterns. To change the flash pattern:

- Turn the power unit ignition key to the engine run position. Do not start the engine.
- Turn the strobe light switch to the On position.
- In the left rear corner of the canopy, locate the harness connector with a cap.
- Remove the cap from the connector.
- Use a jumper wire to connect the two terminals momentarily (less than one second) to change to the next flash pattern. Repeat until the desired flash pattern is reached.
- Turn the strobe light switch to the Off position.
- Turn the ignition key to the Stop position.
- Reinstall the cap onto the connector.

PTO Belt Inspection

Inspecting the PTO belt of this power unit can prevent sudden belt failure by finding problems before they cause a belt to break. Inspect the PTO belt prior to operation, as part of the daily inspection or anytime a problem is suspected. There may be a PTO belt problem if there is a squealing or chattering sound, or the smell of a slipping belt.

Check the PTO belt (A) at the PTO idler pulley (B).

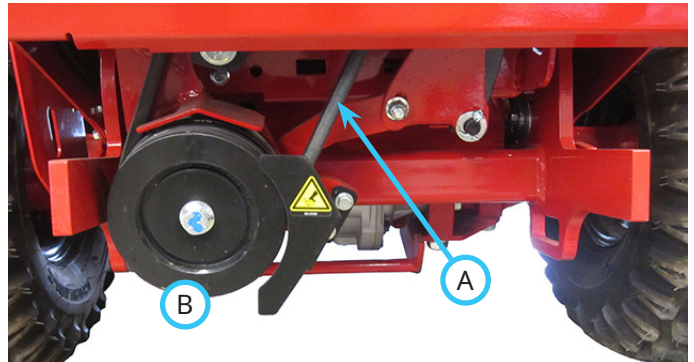

Typical wear on a drive belt may result in the conditions shown in the diagram. If any of these conditions occur, the drive belt will require replacement.

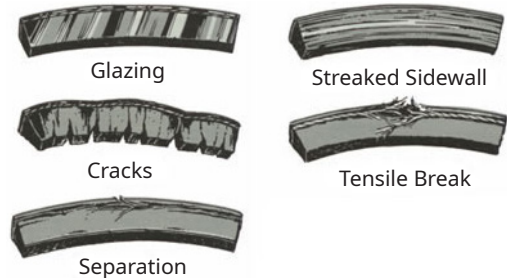

SERVICE

PTO Belt Tension Adjustment

1. Pull out on the PTO belt tensioner rod to release tension from the belt tensioner linkage.
2. Loosen the adjustment bolt (A) and rotate the tension adjustment link (B) clockwise to increase the tension applied to the PTO and attachment belts. Rotate the tension adjustment link counterclockwise to decrease the tension applied to the PTO and attachment belts.

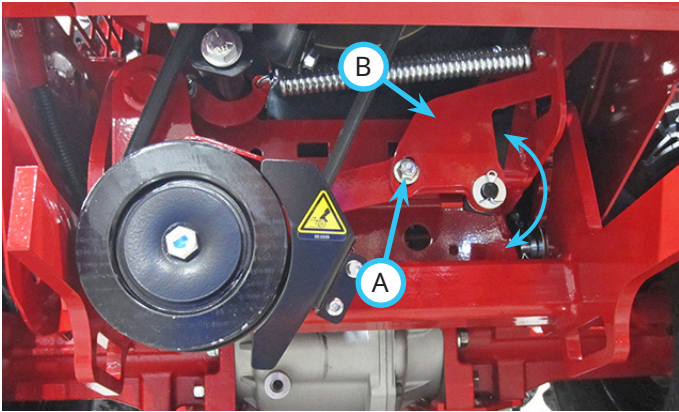

3. Tighten the adjustment bolt securely. Torque to 42 Nm (31 ft-lbs).

PTO Belt Replacement

1. If the power unit has been running, allow the engine to cool.
2. Remove the front grill plate.
3. Remove the PTO idler pulley guard (A).
4. Pull the PTO belt tensioner rod out to release the belt tension.
5. Reach through the grill opening and remove the hairpin (B) and washer that fastens the belt tensioner rod (C) to the belt tension rocker.

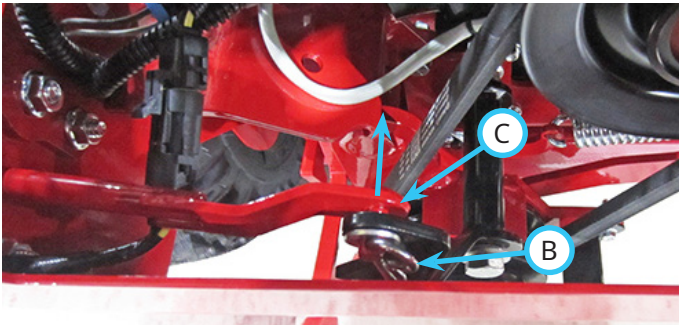
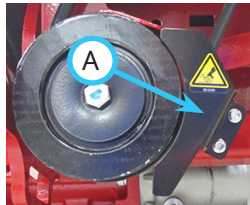

6. Remove the belt tensioner rod from the belt tension rocker.
7. Lift up on the PTO idler pulley and remove the belt from the pulley.
8. Pull the belt up between the PTO tension rocker

- and the front grill and remove from the clutch pulley.
9. Push the new belt down between the PTO tension rocker and the front grill.
10. Install the belt onto the clutch pulley.
11. Lift up on the PTO idler pulley and install the belt into the rear groove of the idler pulley.
12. Reinstall the PTO belt tensioner rod to the belt tension rocker and fasten with the washer and hairpin.
13. Reinstall the PTO idler pulley guard. Torque the bolts to 11 Nm (100 in-lbs).
14. Reinstall the front grill plate.

SERVICE

Clutch Air Gap Inspection and Adjustment

The electric clutch is activated by the PTO switch to engage or disengage power to belt driven attachments. The clutch also provides braking action to stop the attachment when the PTO is disengaged or the operator presence circuit is interrupted.

For proper operation, the air gap between the armature and the rotor must be set at .5 mm (.020 inch). If the air gap is too narrow, the clutch armature may drag when disengaged, causing premature failure. If the air gap is too wide, the clutch may not engage correctly or it may disengage when it becomes hot.

Check the air gap annually and adjust the clutch air gap as needed.

1. Locate the three inspection windows (A) on the clutch.

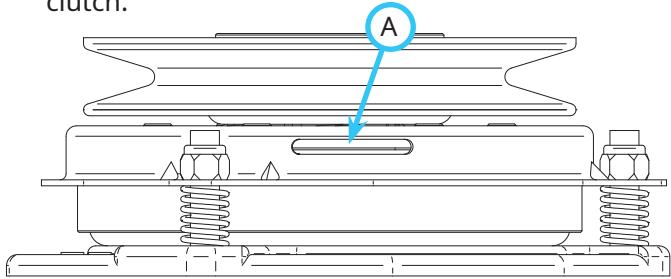

2. Insert a .5 mm (.020 inch) feeler gauge through the inspection window and into the slot between the armature and the rotor.
3. Tighten or loosen the clutch adjustment nut (B) as needed to achieve the .5 mm (.020 inch) air gap.

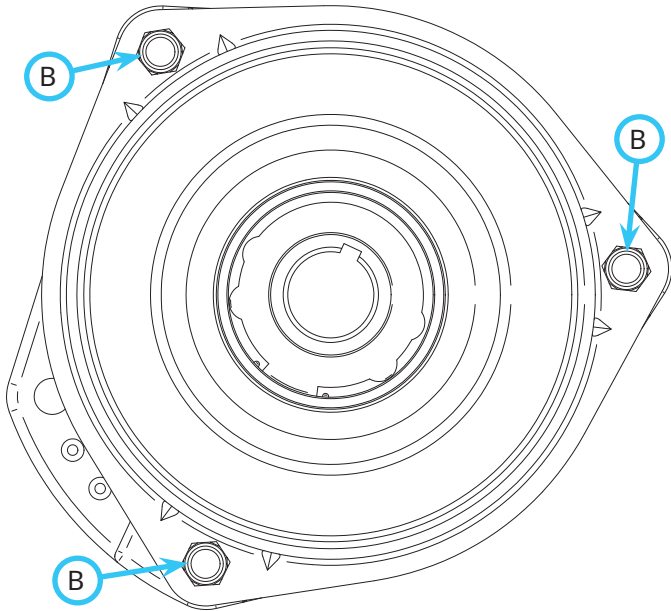

Wheel Removal and Installation

Wheel Removal:

1. Park the power unit on a level surface.
2. Loosen the wheel lug nuts, but do not remove.

WARNING

If the power unit is not adequately supported, the unit could fall and trap or crush a person or appendage, causing severe injury or death.

3. Lift up the corner of the power unit and secure with a jack stand.
4. Remove the lug nuts and lift the wheel off the mounting studs.

Wheel Installation:

1. Place the wheel onto the mounting studs with the hub side of the rim against the axle hub. NOTE: If the wheel is equipped with dual valve stems, there is a decal on the rim that indicates the hub side of the rim.
2. Install the lug nuts and tighten by hand until the wheel is held against the axle hub.
3. Lift the power unit up slightly and remove the jack stand. Lower the power unit to the ground.
4. Tighten the lug nuts in a crisscross sequence as shown. Torque to 75 Nm (55 ft-lbs).

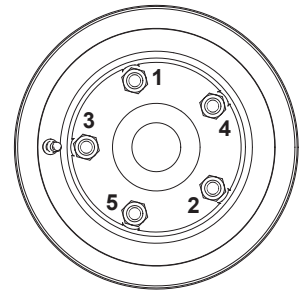

SERVICE

Outer Dual Wheel Removal and Installation

1. Raise the power unit approximately 5 cm (2 inches) by driving the power unit onto wood planks positioned in line with the inner wheels. The outer dual wheels should not contact the wood planks. A jack and jack stands may be used to raise and support the power unit if planks are not available.

⚠ WARNING

Place wheel chocks in front and back of the inner wheels to prevent the power unit from rolling forward or backward during removal or installation of the outer dual wheels.

2. Place wheel chocks in front and back of the inner wheels to prevent accidental movement.

Outer Dual Wheel Removal:

1. Loosen the draw bolts approximately five turns.
2. With a medium size hammer, hit the end of the draw bolt until the draw cone releases.
3. Remove the dual wheel assemblies by rotating them counterclockwise.
4. Install the four plastic plugs from the dual wheel kit into the inner dual wheel hubs.
5. If desired, move the steering cylinder to the inner hole setting of the cylinder mount under the left front corner of the foot platform. Torque to 203 Nm (150 ft-lbs).

Outer Dual Wheel Installation:

1. Remove the plastic plugs from the inner dual wheel hubs.
2. Inspect the threaded end of the dual wheel extensions to ensure the draw cone, the draw bolt, and the external threads of the dual wheel extension have a light coating of grease. Apply grease if necessary.
3. The draw cone must be loose before installing the dual wheel extension into the inner hub. Check by sliding the draw bolt in and out. It should have 6.5 - 13 mm (1/4 - 1/2 inch) of travel.

4. Insert the threaded end of the dual wheel extension into the inner dual wheel hub. Using both hands, turn the dual wheel clockwise until the wheel is tight and there are four threads or fewer visible on the outer wheel extension. This is to ensure the hubs lock correctly when the draw bolt is tightened. Repeat for the other three wheels.



After tightening the outer dual wheel, there should be four or fewer threads visible on the outer dual wheel extension.

5. Tighten the draw bolt and torque to 163 Nm (120 ft-lbs) Repeat for the other three wheels.
6. If the steering cylinder is mounted to the inner hole setting of the steering cylinder mount, move the steering cylinder to the center hole setting of the cylinder mount under the left front corner of the foot platform. Torque to 203 Nm (150 ft-lbs).

Tire Pressure

Keep tires evenly inflated. Keep tire pressures within the proper range to prevent premature wear and/or poor traction.

Tire	Single Wheel	Dual Wheels	
		Inner	Outer
All Terrain	55-110 kPa (8-16 psi)	55-69 kPa (8-10 psi)	41-55 kPa (6-8 psi)
Bar	55-110 kPa (8-16 psi)	55-69 kPa (8-10 psi)	41-55 kPa (6-8 psi)
Turf	103-138 kPa (15-20 psi)	103-117 kPa (15-17 psi)	69-83 kPa (10-12 psi)

SERVICE

ROPS and Seat Belt Inspection

⚠ WARNING

Failure to inspect and maintain the Roll-Over Protection System and the seat belt can lead to serious injury or death.

If any part of the ROPS sustains structural damage, the entire ROPS must be replaced.

1. Inspect the roll bar for damage, missing components, and loose or missing hardware. Replace any damaged or missing components and tighten loose hardware prior to operating the power unit.
2. Inspect the seat belt for cuts, abrasions, fraying, or excessive wear.
3. Inspect the seat belt for damage from exposure to the sun's ultraviolet rays. If the color of the seat belt is extremely faded, its physical strength may be deteriorated.
4. Inspect the seat belt for dust and dirt. If the seat belt is packed with dirt, its physical strength may be deteriorated.
5. Inspect the seat belt for stiffness. If the seat belt is no longer flexible, its physical strength may be deteriorated.
6. Inspect the seat belt buckle and latch for damage, cracks, or excessive wear.
7. Inspect the seat belt for proper operation. The seat belt should latch securely and release smoothly. Seat belt adjustment should be accomplished without excessive resistance.
8. If any problems are detected during this inspection, the component must be replaced prior to operating the power unit.

Parking Brake Inspection and Adjustment

The parking brake tension must be set to require a minimum of 7 kg (15 pounds) of force to engage the brake lever seven clicks or less from the off position. If less than 7 kg (15 pounds) is required to engage the brake lever seven clicks from the off position, or if engaging the parking brake will not prevent the power unit from moving, the brake linkage rod will need to be adjusted.

1. Park the power unit on a level surface.

⚠ WARNING

The parking brake must be disengaged as part of the adjustment procedure. Park the power unit on a level surface and place wheel chocks in front and back of the wheels to prevent the power unit from rolling forward or backward.

2. Place wheel chocks in front and back of the wheels to prevent accidental movement.
3. Disengage the parking brake to remove tension from the brake linkage.
4. Tighten the lock nut (A) on the brake linkage rod several turns and recheck the amount of force required to engage the brake lever. Continue to adjust the lock nut until there is a minimum of 7 kg (15 pounds) of force required to engage the brake lever seven clicks or less from the off position.

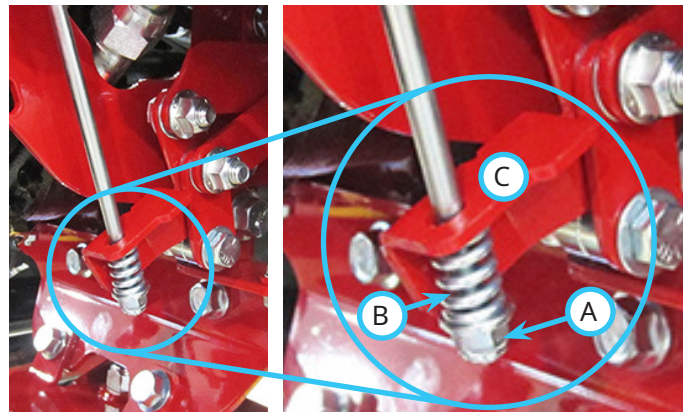

5. After the required amount of force to engage the parking brake is achieved, disengage the parking brake and move the SDLA lever forward to the end of its stroke. While moving the SDLA lever forward, observe the compression spring (B) and the brake engagement tab (C) on the brake linkage. The compression spring should not cause the brake engagement tab to be lifted up more than .8 mm (.03 inches). If the brake engagement tab movement exceeds the specified measurement, it is possible for the brake to drag when travelling at full forward speed, causing premature wear of the brake.
6. If it is not possible to achieve the required park-

SERVICE

ing brake engagement force without causing the brake engagement tab to exceed its movement specification, the parking brake band may require further service. Contact an authorized Ventrac dealer for assistance.

Neutral Adjustment

The power unit should come to a complete stop with the neutral assist lever in the On position and the parking brake disengaged. The power unit should not attempt to move with the parking brake engaged. If the power unit is attempting to move, there will be an excessive amount of pump hydraulic noise, which indicates the pump is not in the neutral position.

If the power unit moves or attempts to move in either condition, the neutral position must be adjusted.

1. Remove any attachment from the power unit.
2. Park the power unit on a level surface.
3. Remove the pump cover from the power unit.

⚠ WARNING

Do not attempt to adjust the neutral position with the power unit wheels on the ground. The power unit could move forward or backward unexpectedly, causing severe injury or death.

If the power unit is not adequately supported, the unit could fall and trap or crush a person or appendage, causing severe injury or death.

4. Lift the power unit so that all four wheels are a minimum of 5 cm (2 inches) off the ground and secure the power unit with jack stands or supporting blocks. Ensure the jack stands or supporting blocks will not make contact with the wheels when they rotate.
5. Place a weight of 22.5 kg (50 pounds) on the seat so the operator presence switch is activated.
6. Place the neutral assist lever in the On position to engage the neutral assist spring.
7. Start the power unit and adjust the engine speed to approximately 2,000 RPM.

8. Locate the neutral adjustment bolt (A) on the lower right side of the front frame (right column panel), directly below the neutral assist lever.

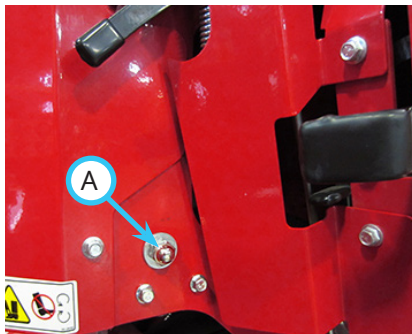

9. Loosen the neutral adjustment nut (A) slightly. NOTE: it is easier to attain the desired setting if the neutral adjustment nut is left snug and a rubber mallet or a piece of wood and a hammer are used to tap the nut in the desired direction. Do not strike the nut directly with a metal hammer, as it is possible to dent or damage the nut.
10. Release the parking brake and observe the direction the tires are rotating. If the tires are rotating in the forward direction, the neutral adjustment nut should be moved up in the frame slot. If the tires are rotating in the reverse direction, the neutral adjustment nut should be moved down in the frame slot.
11. Once the proper neutral position is achieved and the tires no longer rotate, tighten the neutral adjustment nut to 42 Nm (31 ft-lbs). Make sure to hold the bolt head to help prevent the bolt from moving in the frame slot while the nut is tightened.
12. Verify that the neutral position is still correct after tightening the nut by moving the SDLA lever in the forward and reverse directions and allowing the spring return to move the lever back to the neutral position. Observe the tires to see if there is any movement. Repeat steps 9-11 as needed until there is no movement of the tires.
13. Engage the parking brake and listen for abnormal amounts of pump hydraulic noise. Repeat steps 9-11 if necessary.
14. Engage the parking brake and shut off the engine.
15. Remove the weight from the power unit seat.
16. Remove the power unit from the jack stands or supporting blocks and return to the ground.

⚠ WARNING

An improperly adjusted neutral switch can result in erratic engine cranking or unsafe power unit movement. Check the neutral switch position after any adjustment is made to the neutral position.

17. Adjustments made to the neutral position bolt may affect the neutral switch setting. After changing the neutral setting, it is possible that the power unit will not start, due to the neutral switch being out of adjustment. After any adjustments are made to the neutral position, the neutral switch should be checked and, if necessary, adjusted by an authorized Ventrac dealer.

SERVICE

Neutral Switch Adjustment

WARNING

An improperly adjusted neutral switch can result in erratic engine cranking or unsafe power unit movement. Check the neutral switch position after any adjustment is made to the neutral position.

If the neutral switch needs to be checked or adjusted, contact an authorized Ventrac dealer.

Storage

Preparing the Power Unit for Storage

1. Clean the power unit.

ATTENTION

To maintain the finish of the power unit, thoroughly wash the equipment to remove any corrosive agents (e.g., salt). Failure to clean the equipment may result in corrosion of (including but not limited to) steel, aluminum, and electrical components.

2. Inspect for loose or missing hardware, damaged components, or signs of wear. Repair or replace any damaged or worn components.
3. Inspect the ROPS structure and seat belt for signs of damage or wear.
4. Inspect the safety decals. Replace any decals that are faded, illegible, or missing.
5. Inspect the hydraulic hoses and fittings for leaks and/or wear. Service as required.
6. Inspect the fuel lines for leaks.
7. Perform the parking brake inspection.
8. Inspect the electrical system and connections.
9. Test the operator safety interlock system.
10. Inspect the PTO pulley and belt for damage or excessive wear. Service as required.
11. Perform the PTO clutch air gap inspection.
12. Check the hydraulic oil level. Add fluid or service as required.
13. Check the coolant level and make sure the temperature protection range is at least -37°C (-34°F). Add fluid or service as required.
14. Clean the radiator screen, the radiator, and the engine compartment.
15. Check the tires for proper inflation.
16. Grease or lubricate all points specified in the Lubrication section. Wipe off any excess grease or oil.
17. Inspect the painted components for chips, scratches, or rust. Clean and touch up the surfaces as needed.

After all the above steps have been performed, complete the preparation for storage by performing the steps for either long term storage (four months or longer) or short term storage (less than four months).

SERVICE

Long Term Storage (four months or longer)

1. Change the engine oil to prevent damage that can be caused by acidic buildup in used motor oil.
2. Drain all the fuel out of the fuel tank, start the power unit's engine, and allow to run until the engine stops to ensure all the fuel is out of the fuel lines, carburetor passages, injectors, etc.
3. Turn the key to the Off position and remove the ignition key.
4. Engage the parking brake.
5. Turn the fuel shut-off valve to the Off position.
6. Turn the battery disconnect to the Off position.
7. If the power unit is being stored in a cold climate (below 2° C [35° F]), remove the battery from the power unit and store in a warm location. Check the battery charge periodically and charge the battery, if needed.

Short Term Storage (less than four months)

1. Add a quality gasoline fuel stabilizer to the fuel tank. Follow the manufacturer's recommended mixing ratios.
2. Start the power unit's engine and run for ten minutes to allow the fuel stabilizer to travel all through the fuel system.
3. Shut off the engine and remove the ignition key.
4. Engage the parking brake.
5. Turn the fuel shut-off valve to the Off position.
6. Turn the battery disconnect to the Off position.
7. Check the battery charge periodically and charge the battery, if needed.

Removing the Power Unit from Storage

1. Clean the power unit to remove any accumulated dust or debris.
2. Inspect the power unit as instructed in the Daily Inspection section of this manual.
3. Test the power unit to ensure that all the components and systems are working properly.

SERVICE

Maintenance Schedule

Maintenance Schedule	# of locations	# of pumps	As Needed	After First 8 Hrs.	Daily	At 50 hours	At 100 hours	At 150 hours	At 200 hours	At 250 hours	At 300 hours	At 350 hours	At 400 hours	At 450 hours	At 500 hours	At 550 hours	At 600 hours	At 650 hours	At 700 hours	At 750 hours	At 800 hours	At 850 hours	At 900 hours	At 950 hours	At 1,000 hours	Yearly	1,500 Hours*
Grease and Lubrication: Refer to the Lubrication Section																											
Front Hitch	2	1	✓			✓	✓	✓	✓	✓	✓	✓	✓	✓	✓	✓	✓	✓	✓	✓	✓	✓	✓	✓	✓	✓	✓
Lift Cylinder	2	1	✓			✓	✓	✓	✓	✓	✓	✓	✓	✓	✓	✓	✓	✓	✓	✓	✓	✓	✓	✓	✓	✓	✓
Center Pivot	1	1	✓			✓	✓	✓	✓	✓	✓	✓	✓	✓	✓	✓	✓	✓	✓	✓	✓	✓	✓	✓	✓	✓	✓
Steering Cylinder	2	1	✓			✓	✓	✓	✓	✓	✓	✓	✓	✓	✓	✓	✓	✓	✓	✓	✓	✓	✓	✓	✓	✓	✓
Drive Shaft	2	1	✓			✓	✓	✓	✓	✓	✓	✓	✓	✓	✓	✓	✓	✓	✓	✓	✓	✓	✓	✓	✓	✓	✓
3 Point Cylinder (if equipped)	2	1	✓			✓	✓	✓	✓	✓	✓	✓	✓	✓	✓	✓	✓	✓	✓	✓	✓	✓	✓	✓	✓	✓	✓
3 Point Hitch Pivot (if equipped)	2	1	✓			✓	✓	✓	✓	✓	✓	✓	✓	✓	✓	✓	✓	✓	✓	✓	✓	✓	✓	✓	✓	✓	✓
Lower Connector Link	2	1	✓			✓	✓	✓	✓	✓	✓	✓	✓	✓	✓	✓	✓	✓	✓	✓	✓	✓	✓	✓	✓	✓	✓
Seat Slide	2	#	✓			✓	✓	✓	✓	✓	✓	✓	✓	✓	✓	✓	✓	✓	✓	✓	✓	✓	✓	✓	✓	✓	✓
Engine ¹																											
Check the Engine Oil Level				✓																							
Change the Engine Oil and Filter ¹			✓			✓		✓					✓			✓					✓				✓		
Clean or Replace the Spark Plugs																											
Inspect the Primary Air Filter					✓																						
Replace the Primary Air Filter	**					**		✓		**		✓	**		✓	**		✓	**		✓	**		✓	**		✓
Replace the Safety Air Filter													✓								✓						
Check the Coolant Level				✓																							
Service the Cooling System																											✓
Clean the Engine Compartment, Engine, and Radiator	**		✓																								
Replace the Fuel Filter	✓												✓									✓					
Drain Water and Sediment from Fuel Tank	✓																										✓
Hydraulic System																											
Check the Hydraulic Oil Level				✓																							
Check the Rear Transaxle Oil Level									✓						✓						✓					✓	✓
Change the Hydraulic Filters ²						✓								✓													✓
Change the Hydraulic Oil and the Rear Transaxle Oil														✓													✓
Parking Brake																											
Parking Brake Inspection and Adjustment				✓																							
Electrical																											
Clean the Battery Terminals and Compartment	✓																										✓
Inspection																											
Inspect the Operator Interlock System				✓																							
Inspect the ROPS Structure and Seat Belt				✓																							
Inspect for Loose, Missing, or Worn Components				✓																							
Inspect the Battery, Electrical Connections, and Lights				✓																							
Inspect the Belts, Fuel Lines, and Hydraulic Lines				✓																							
Check the Tire Pressure				✓																							
Check the Wheel Lug Nuts. Torque to 75 Nm (55 ft-lbs)					✓	✓	✓	✓	✓	✓	✓	✓	✓	✓	✓	✓	✓	✓	✓	✓	✓	✓	✓	✓	✓	✓	✓
Check the Steering Cylinder Bolts. Torque to 203 Nm (150 ft-lbs)						✓		✓		✓		✓		✓		✓		✓		✓		✓		✓		✓	
Check the Front/Rear Connector Link Bolts. Torque to 203 Nm (150 ft-lbs)						✓		✓		✓		✓		✓		✓		✓		✓		✓		✓		✓	
Check the Front Hitch Pivot Bolts. Torque to 203 Nm (150 ft-lbs)						✓		✓		✓		✓		✓		✓		✓		✓		✓		✓		✓	
*Follow service intervals for heavy loads and high temperatures. If unspecified, service at one-half the standard service interval.																											
**Operation in severe conditions may require more frequent service intervals.																											
¹ Consult the Engine Owner's Manual for engine oil information and complete servicing information.																											
*Silicon Based Spray Lubricant																											
² Hydraulic filters initial change at 100 hours. Change the hydraulic oil and filters at 500 hours, then every 1,000 hours.																											

SERVICE

Maintenance Checklist

Maintenance Checklist	# of locations	# of pumps	As Needed	After First 8 Hrs.	Daily	At 50 hours	At 100 hours	At 150 hours	At 200 hours	At 250 hours	At 300 hours	At 350 hours	At 400 hours	At 450 hours	At 500 hours	At 550 hours	At 600 hours	At 650 hours	At 700 hours	At 750 hours	At 800 hours	At 850 hours	At 900 hours	At 950 hours	At 1,000 hours	Yearly	1,500 Hours*
Grease and Lubrication: Refer to the Lubrication Section																											
Front Hitch	2	1																									
Lift Cylinder	2	1																									
Center Pivot	1	1																									
Steering Cylinder	2	1																									
Drive Shaft	2	1																									
3 Point Cylinder (if equipped)	2	1																									
3 Point Hitch Pivot (if equipped)	2	1																									
Lower Connector Link	2	1																									
Seat Slide	2	#																									
Engine¹																											
Check the Engine Oil Level																											
Change the Engine Oil and Filter ¹																											
Clean or Replace the Spark Plugs																											
Inspect the Primary Air Filter																											
Replace the Primary Air Filter																											
Replace the Safety Air Filter																											
Check the Coolant Level																											
Service the Cooling System																											
Clean the Engine Compartment, Engine, and Radiator																											
Replace the Fuel Filter																											
Drain Water and Sediment from Fuel Tank																											
Hydraulic System																											
Check the Hydraulic Oil Level																											
Check the Rear Transaxle Oil Level																											
Change the Hydraulic Filters ^{**}																											
Change the Hydraulic Oil and the Rear Transaxle Oil																											
Parking Brake																											
Parking Brake Inspection and Adjustment																											
Electrical																											
Clean the Battery Terminals and Compartment																										✓	
Inspection																											
Inspect the Operator Interlock System																											
Inspect the ROPS Structure and Seat Belt																											
Inspect for Loose, Missing, or Worn Components																											
Inspect the Battery, Electrical Connections, and Lights																											
Inspect the Belts, Fuel Lines, and Hydraulic Lines																											
Check the Tire Pressure																											
Check the Wheel Lug Nuts. Torque to 75 Nm (55 ft-lbs)																											
Check the Steering Cylinder Bolts. Torque to 203 Nm (150 ft-lbs)																											
Check the Front/Rear Connector Link Bolts. Torque to 203 Nm (150 ft-lbs)																											
Check the Front Hitch Pivot Bolts. Torque to 203 Nm (150 ft-lbs)																											
*Follow service intervals for heavy loads and high temperatures. If unspecified, service at one-half the standard service interval.																											
**Operation in severe conditions may require more frequent service intervals.																											
¹ Consult the Engine Owner's Manual for engine oil information and complete servicing information.																											
[*] Silicon Based Spray Lubricant																											
^{**} Hydraulic filters initial change at 100 hours. Change the hydraulic oil and filters at 500 hours, then every 1,000 hours.																											

SERVICE

Maintenance Log

Serial Number:

4520P - □□□□□□□□

Date:	Hours:	Description of Repairs/Service	Initials

SERVICE

Maintenance Log

Date:	Hours:	Description of Repairs/Service	Initials

TROUBLESHOOTING

Engine

Symptom:	Possible Cause:
The starter will not engage.	The battery disconnect switch is in the Off position. A blown fuse in the power relay module. A blown fuse in the start circuit. The parking brake is not engaged. The parking brake switch is out of adjustment. The power unit is not in neutral. The neutral switch is out of adjustment. Low battery voltage.
The engine cranks, but won't start.	The fuel shut-off valve is turned off. The fuel tank is empty. A faulty fuel pump. A plugged fuel filter. A blockage in the fuel line. Poor engine compression.
The engine runs rough.	Plugged or partially plugged air filter(s). Plugged or partially plugged fuel filter. Stale, dirty fuel or wrong seasonal fuel mixture. The fuel level is low. Faulty spark plugs. Moisture in the spark plug pockets. A faulty fuel pump. Dirty or faulty fuel injectors. Incorrect valve clearance. Valve seat failure.
The engine is low on power.	Plugged or partially plugged air filter(s). Plugged or partially plugged fuel filter. Dirty or faulty fuel injectors. Low cylinder compression.
The engine overheats.	The radiator screen is dirty. The coolant level is low. The engine compartment has debris buildup. The radiator cap is defective. The thermostat is defective. The alternator / fan belt is loose. A blown head gasket.

TROUBLESHOOTING

Engine (Continued)

Symptom:	Possible Cause:
The oil light comes on when the engine is running.	The oil level is low. A faulty oil sender. A faulty or plugged oil pump.
The engine emits white smoke.	The engine temperature is low. A faulty head gasket. There is water in the combustion chamber.
The engine uses excessive fuel.	Plugged or restricted air filters or air intake hoses. Dirty or faulty fuel injectors.
The engine uses excessive oil.	The engine has an oil leak. The oil is an incorrect viscosity. Plugged or restricted air filters or air intake hoses. The engine has worn rings or cylinder walls. The engine has worn or faulty valves.

Electrical

If there is an electrical issue:

- a. Check the battery disconnect switch to ensure that it is turned on.
- b. **[Serial # 01001-02232]** Check the 15 amp fuse in position F10 and the 5 amp fuse in position F08. Replace the fuses if necessary.
[Serial # 02232-] Check the 15 amp fuse in position F06 and the 5 amp fuse in position F03. Replace the fuses if necessary.
- c. If the electrical issue affects the safety related functions controlled by the TCS, the power unit should be taken to an authorized Ventrac dealer for troubleshooting using diagnostic tools.

Symptom:	Possible Cause:
The battery does not charge.	Loose or corroded battery connections. A broken or loose wire in the charge system. A blown fuse or fuse link in the charge system. The battery is defective. The alternator / fan belt is loose. A faulty regulator. A faulty alternator.
The lights do not activate.	A blown fuse. A faulty light. A broken wire. A faulty light switch.

TROUBLESHOOTING

Electrical (Continued)

Symptom:	Possible Cause:
The PTO does not engage.	A blown fuse. A faulty seat switch (operator must be on seat). A faulty PTO switch. PTO belt failure. The PTO clutch air gap is out of adjustment. A faulty clutch.

Hydraulic

Symptom:	Possible Cause:
The front attachment does not lift.	The hydraulic oil level is low. An excessive load on the front lift. The hydraulic oil suction filter is plugged. A faulty hydraulic lift cylinder. The pump charge pressure is low. Missing hardware on the lift cylinder. Missing hardware on the SDLA lever links.
Steering is difficult.	The hydraulic oil level is low. The hydraulic oil suction filter is plugged. A faulty steering cylinder. The pump charge pressure is low. An excessive load on the hydraulic system.
Excessive noise in the hydraulic system.	The hydraulic oil level is low. The hydraulic oil suction filter is plugged. Incorrect oil used in the hydraulic system. Cold weather - allow the power unit to warm up.
The hydraulic system overheats.	The circuit breaker for the hydraulic cooling fan is tripped. The hydraulic cooler is dirty/plugged . A faulty hydraulic cooling fan temperature sender. A faulty hydraulic cooling fan. The hydraulic system is overstressed (using high range instead of low range for heavy work loads).

TROUBLESHOOTING

Power Unit

Symptom:	Possible Cause:
The power unit will not move with the engine running.	The high/low shift lever is in the neutral position. The hydraulic oil level is low. The parking brake is not disengaging. The pump control arm connecting linkage is loose or disconnected. The tow valve is bypassing at the hydraulic pump. The universal joint at the engine/hydraulic pump is loose. A faulty hydraulic pump or motor.
The engine stalls whenever the SDLA control lever is moved forward or backward out of neutral.	The parking brake switch or the neutral switch is out of adjustment.

SPECIFICATIONS

Engine

Model	4520P
Manufacturer	Kawasaki
Model Number	FD851D
Type	Gasoline
Cylinders.	2
Displacement	824 cc
Engine Gross Power	23.1 kW (31 hp)
Operating Range (RPM)	1,550-3,650
Cooling System	Liquid Cooled
Alternator	30 Amp

Electrical

Battery	500 Cold Cranking Amps
Voltage.	12 Volts

Power Train

Type	Hydrostatic (All Wheel Drive)
Hydrostatic Transaxle (2)	Peerless
Forward Speed (High)*.	16.1 km/h (10 mph)
Forward Speed (Low)*.	8.4 km/h (5.2 mph)
Brakes	Hydro-Dynamic
Hydraulic Oil Filtration	10 Micron and 25 Micron

Controls and Instrument Panel

Steering	Power
PTO (Power Take Off).	Electric w/brake
Throttle Control.	Cable
Directional Control	Speed, Direction, Lift, Auxiliary (SDLA)
Control Orientation	Hand
Gauges.	Tachometer, Volt, Water Temperature, Fuel, Speedometer
Parking/Emergency Brake.	Band Brake

Other Features

Turning Radius	99 cm (39 inches)
Standard Tires	All Terrain (22 x 12-8) (56 x 30-20 cm)
Optional Tires.	Turf (22 x 11-10)(56 x 28-26 cm)
Optional Tires.	Bar (21 x 11-8)(53 x 28-20 cm)
Headlight	LED (1,000 lumen)
Attachment System	Ventrac Mount

*May vary based on the tire size, type, and inflation.

SPECIFICATIONS

Dimensions

Wheelbase.114 cm (45 inches)
Overall Length208 cm (82 inches)
Overall Height (top of ROPS bar)170 cm (67 inches)
Overall Width (single tires)*.122 cm (48 inches)
Overall Width (dual tires)*.185 cm (73 inches)
Weight**	735 kg (1,620 pounds)

Ventrac Products, Inc. reserves the right to change these specifications without notice.

*May vary based on the tire size, type, and inflation.

**Weight varies based on the engine size, tire options, and optional accessories.

Fluid Capacities and Specifications

	Fluid Type	Capacity	Filter #1	Filter #2
Engine Oil	Synthetic 10W-30 [*]	1.9 liters (2.0 quarts)	13.0268	
Hydraulic Oil (Front trans-axle and Reservoir)	HydroTorq XL Synthetic Hydraulic Oil	11.6 liters (12.3 quarts) Optional 3-point hitch 12.2 liters (13 quarts)	21.0122 (Suction filter)	21.0124 (Return filter)
Hydraulic Oil (Rear trans-axle)	HydroTorq XL Synthetic Hydraulic Oil	4.4 liters (4.6 quarts)	-	-
Cooling System	50% distilled water and 50% ethylene glycol antifreeze [^]	6.6 liters (7 quarts)	-	-
Fuel System	Unleaded Gasoline (Max 10% Ethanol)	22.7 liters (6 gallons)	13.0053	-
Grease	Lithium Complex NLGI #2	Refer to the Maintenance Chart	-	-

^{*} = Use API Classification SH, SJ, or higher. For optimal engine life and performance, use Ventrac full synthetic engine oil (Part Number 15.0037-1).
[^]Recommended antifreeze: a low silicate, phosphate free antifreeze (ethylene glycol) containing supplemental coolant additives (SCAs) to inhibit corrosion and rust.

Visit ventrac.com/manuals
for the latest version of this operator's manual.
A downloadable parts manual is also available.

View all manuals



WARRANTY

CALIFORNIA EVAPORATIVE EMISSION CONTROL WARRANTY STATEMENT

YOUR WARRANTY RIGHTS AND OBLIGATIONS

The California Air Resources Board and Venture Products, Inc. are pleased to explain the evaporative emission control system's warranty on your 2020-2021 model year Ventrac power unit. In California, new equipment must be designed, built, and equipped to meet the State's stringent anti-smog standards. Venture Products, Inc. must warrant the evaporative emission control system on your power unit for the period listed below provided there has been no abuse, neglect or improper maintenance of your equipment leading to the failure of the evaporative emission control system.

Your evaporative emission control system may include parts such as: carburetors, fuel tanks, fuel lines (for liquid fuel and fuel vapors), fuel caps, valves, canisters, filters, clamps, connectors, and other associated components.

MANUFACTURER'S WARRANTY COVERAGE

This evaporative emission control system is warranted for two years. If any evaporative emission-related part on your equipment is defective, the part will be repaired or replaced by Venture Products, Inc.

OWNER'S WARRANTY RESPONSIBILITIES

As the power unit's owner, you are responsible for performance of the required maintenance listed in your owner's manual. Venture Products, Inc. recommends that you retain all receipts covering maintenance on your power unit, but Venture Products, Inc. cannot deny warranty coverage solely for the lack of receipts.

As the power unit owner, you should be aware that Venture Products, Inc. may deny you warranty coverage if your power unit or a part has failed due to abuse, neglect, or improper maintenance or unapproved modifications.

You are responsible for presenting your power unit to a Venture Products, Inc. distribution center or service center as soon as the problem exists. The warranty repairs shall be completed in a reasonable amount of time, not to exceed 30 days. If you have a question regarding your warranty coverage, you should contact Venture Products, Inc. at 1-866-836-8722.

GENERAL EMISSIONS WARRANTY COVERAGE

Venture Products, Inc. warrants to the ultimate purchaser and each subsequent purchaser that the power unit is:

1. Designed, built and equipped so as to conform with all applicable regulations; and
2. Free from defects in materials and workmanship that cause the failure of a warranted part to be identical in all material respects to that part as described in Venture Products, Inc.'s application for certification.

The warranty period begins on the date the power unit is delivered to an ultimate purchaser or first placed into service. The warranty period is two years.

Subject to certain conditions and exclusions as stated below, the warranty on emission-related parts is as follows:

1. Any warranted part that is not scheduled for replacement as required maintenance in the written instructions supplied, is warranted for the warranty period stated above. If the part fails during the period of warranty coverage, the part will be repaired or replaced by Venture Products, Inc. according to subsection (4) below. Any such part repaired or replaced under warranty will be warranted for the remainder of the period.
2. Any warranted part that is scheduled only for regular inspection in the written instructions supplied is warranted for the warranty period stated above. Any such part repaired or replaced under warranty will be warranted for the remaining warranty period.
3. Any warranted part that is scheduled for replacement as required maintenance in the written instructions supplied is warranted for the period of time before the first scheduled replacement date for that part. If the part fails before the first scheduled replacement, the part will be repaired or replaced by Venture Products, Inc. according to subsection (4) below. Any such part repaired or replaced under warranty will be warranted for the remainder of the period prior to the first scheduled replacement point for the part.

WARRANTY

4. Repair or replacement of any warranted part under the warranty provisions herein must be performed at a warranty station at no charge to the owner.
5. Notwithstanding the provisions herein, warranty services or repairs will be provided at all of our distribution centers that are franchised to service the subject engines or equipment.
6. The power unit owner will not be charged for diagnostic labor that is directly associated with diagnosis of a defective, emission-related warranted part, provided that such diagnostic work is performed at a warranty station.
7. Venture Products, Inc. is liable for damages to other engine or equipment components proximately caused by a failure under warranty of any warranted part.
8. Throughout the power unit warranty period stated above, Venture Products, Inc. will maintain a supply of warranted parts sufficient to meet the expected demand for such parts.
9. Any replacement part may be used in the performance of any warranty maintenance or repairs and must be provided without charge to the owner. Such use will not reduce the warranty obligations of Venture Products, Inc.
10. Add-on or modified parts that are not exempted by the Air Resources Board may not be used. The use of any non-exempted add-on or modified parts by the ultimate purchaser will be grounds for disallowing a warranty claims. Venture Products, Inc. will not be liable to warrant failures of warranted parts caused by the use of a non-exempted add-on or modified part.

WARRANTED PARTS

The repair or replacement of any warranted part otherwise eligible for warranty coverage may be excluded from such warranty coverage if Venture Products, Inc. demonstrates that the power unit has been abused, neglected, or improperly maintained, and that such abuse, neglect, or improper maintenance was the direct cause of the need for repair or replacement of the part. That notwithstanding, any adjustment of a component that has a factory installed, and properly operating, adjustment limiting device is still eligible for warranty coverage. The following emission warranty parts list are covered:

- Carbon canister
- Fuel tank
- Vent rollover valve
- Fuel line fittings
- Fuel line clamps
- Fuel line (for liquid fuel and fuel vapors)
- Fuel cap